

ACCESS CONTROL SOLUTIONS

LAST REVISION 10/3/2018

Owners Manual and Software guide

Eternity 4

Eternity 5



TABLE OF CONTENTS

SECTION 1 - GENERAL OVERVIEW 4

I. Foreword.....4
About This Manual4
Safety Warnings and Cautions.....4
Design Change Disclaimer.....4
Reproduction Disclaimer4
Technical Support4
II. Important information.....4
Manufacture Default Code Setting:4
LED and Audio Indicator:.....4
Important Keys:.....5
III. General Lock Spec.....6
IV. Eternity 4 Datasheet (Heavy Duty keypad Lock)7
Hardware Spec7
Functions.....7
Ordering Information7
Door Prep9
Parts List10
Eternity 4 Installation Instruction.....11
V. Eternity 5 Datasheet (Medium Duty keypad Lock)12
Hardware Spec12
Software Spec12
Mortise Spec12
Ordering Information:.....12
Eternity 5 Installation.....14
Eternity 5 Mortise-Installation16

SECTION 2 - IKEYPAD V3.7 SOFTWARE GUIDE 19

1. SOFTWARE SETUP19
Operating System.....19
Installing 1-Wire USB Driver First.....19
Installing the iKeypad Software.....19
Login.....20
Change System Password20
2. ACCESS CONTROL MANAGEMENT I.....21
I. Lock Setup21
New Lock Set Up.....21
Edit An Existing Lock.....24
II. User Setup.....25
Onsite User Setting25
Add/Edit user information.....25
Assigning User to lock to Locks27
Copy Lock Setting30
3. ACCESS CONTROL MANAGEMENT II.....30
III. Time Setting30
Time Shift Setting30
Timed Operation Setting.....33
Activation / Expiration Date Setting.....34
Exception Date Setting.....36
IV. Lock Management38
Set Parameter Key.....38
Set Time Key39

Get Information Key	40
Lockout Key.....	41
One-Off key/One-Off Code	41
➤ One-Off Key	42
➤ One-Off Code.....	43
V. Audit Trial	44
VI. History	46
Lock Audit History	46
Operator Log.....	47

SECTION 3 NON-SOFTWARE GUIDE 48

I. General Information:	48
II. Manufacture Default Setting:	48
III. Steps to setup a new lock:	49
IV. Types to operate the lock:.....	49
V. Terms:.....	49
VI. Functions:	49
Weekly Chart	52
• How to program schedule with an “user code”.....	52

SECTION 5 TROUBLE SHOOTING GUIDE 53

WARRANTY REGISTRATION FORM 54

Section 1 General Overview

I. Foreword

About This Manual

This manual is designed for users of Eternity 4 and Eternity 5. All installation, setup, operational information, procedures, screen captures, and other relevant materials are contained in this manual.

Safety Warnings and Cautions

When handling a printed circuit board (PCB), guard against possible static discharges by touching a grounded object BEFORE touching the board. Static shock could cost unexpected damage of the board.

Design Change Disclaimer

Due to design changes and product improvements, information in this manual is subject to change without notice. Uaccess LLC assumes no responsibility for any errors that may appear in this manual.

Reproduction Disclaimer

Neither this manual nor any part of it may be reproduced, photocopied, or electronically transmitted in any way without the written permission of Uaccess LLC.

Technical Support

When you experience any difficulty installing or operating the Eternity software, please contact your local distributor or Uaccess LLC at 1-972-820-6450.

II. Important information

Manufacture Default Code Setting:

1. Default Setting for Login User Name / Password is: dallas / ibutton
2. Operator Password: The default operator password is 00000000 (8 digit Zeros)
3. System Facility Code: The default System password is 000000 (6 digit Zeros) Once changed, it cannot be changed back to the manufacturer's default.

LED and Audio Indicators:

1. Program Mode: LED indicating GREEN, audio end with two beeps (**Successful**)
2. Program Mode: LED indicating RED, audio end with one beep (**Fail**)
3. Key Access Mode: LED indicating GREEN, audio end with two beeps (**Valid Access**)
4. Key Access Mode: LED indicating Red, audio end with one beep (**Fail**)
5. Unlock Mode: LED flashing GREEN, lock is in unlock mode
6. Lock Mode: LED flashing RED, lock is in lock mode

Important iButton Keys:

Overview:

iButtons are NOT normally magnetic and will not affect credit cards, watches, or pacemakers. They typically do not emit radiation of any kind. Stainless steel iButtons are normally pressed into colored plastic tags at the factory to make identification and use easier. Key-fob tag colors available are white, yellow, pink, red, orange, blue-green, dark-green, purple, or black. Since all stainless steel iButtons are identical in size and shape they can be provided in any of the available color key-fob tags by special order. However, there are various default colors for various key types if a particular color isn't specified when ordered from the manufacturer or distributor.

If in doubt as to the actual key type, you can identify the iButton model number by looking on the metal end cap with a magnifying glass. The model number beginning with 'DS-' is imprinted there. Some iButtons contain special functions such as digital memory or real-time clocks, while others merely identify specific users.

The following list contains the most commonly used iButtons:

1. DS1990 - **User Key**, each key has a digital serial number that cannot be duplicated. Once programmed into lock memory as a valid user, can be used to lock or unlock locks. (Default key-fob colors : red, yellow, black, orange, dark-green, brown)
2. DS1904 or DS1994 - Contain an on board **real time clock** used to reset the lock internal clock. Either one can be generally used interchangeably with the locks and software (Default key-fob color : Blue-Green)
3. DS1977- **Program Key**. Use to move programming to / from locks (Default key-fob color : Purple)

III. General Lock Spec

This page shows the similar specifications of the Eternity 4 and Eternity 5.

Keypad: 12 key weather-resistant numeric keypad

Keypad Functions: Permanent codes, Temporary codes, one-time service codes

Power Supply: 4 standard AA batteries with an inside battery pack for all weather conditions

Power Supply Life Expectancy: 10,000 operations, low battery warning when system drops below 4.8 volts

Memory Retention: Flash memory never loses memory even without power (except current time and date)

Programming / Communication Method: iButton key-fob, no annoying wires

Functions: Timed lock functions, (automatically unlock or lock), fully programmable exception dates (holidays), temporary dates, and time restrictions for keypad code users and iButton key-fobs.

Finishes: Brushed Chrome or Brushed Brass. (Brushed brass E5 only)

Handles: Reversible Levers, inner and outer

Audit Trail: 3000-event audit trail.

Users: 299, can be a mix of keypad codes and iButton key-fobs

Temporary Codes: 10 limit

One Time service code: 10

Anti-tamper: Red-warning light stays on for 60 seconds after 3 consecutive invalid code entries

Mechanical Key Bypass: Standard on all units

Door Preparation: Standard ANSI A115 Series Prep, optional by adding additional 5/8" through-bolt hole to add stability to the lock and increase security.

Strike Plate: ANSI Standard 115.3. Square corner, 1-1/8 x 2-3/4 inch T strike with 1-1/4 lip-to-center dimension.

Latch: 2 3/4 inch backset standard (2 3/8 inch backset optional), solid brass with 1/2-inch throw 1-inch diameter bore is required.

Materials: Zinc Alloy

Temperature: 0°F-120°F (-18°C-50°C)

Exposure: Limited *direct* rain or water conditions.

Accessibility Standard: Meets ADA standards (Americans with Disabilities Act)

Lock Back Time: 1 – 25 seconds (default is 5 seconds)

Working Voltage: 4.8-6.4V

Low Battery Warning: 4.8V or lower

Door Thickness: 1 3/8" to 2"

Keyway: Schlage C6 – (IC or Best compatible available as extra cost option for E5 only as handle option E5ICHDL.)

Hardware Spec

PARAMETER	DETAIL
Lock Weight	6 Lb
Working Current	<250 mA
Idle Current	5 μ A
Lock Back Time	5 (1 – 25) Seconds
Working Voltage	4.8-6.4V
Low Battery Warning	4.8V or lower
Power Source	4 AA Alkaline Batteries
Keypad	Weather Resistant Keypad
Handle	Reversible Lever
Door Thickness	1 3/8" to 2"
Keyway	Schlage C 6
Motor Run Time	.6 seconds (adjustable)
Packed Size	
Packed Weight	
CTN Size	



Functions

DESCRIPTION	SOFTWARE	NON-SOFTWARE
Audit Trail	Yes (3000 entries)	N/A
iButton Key Users	299 (Combined iButton and code)	299 (Combined iButton and code)
Keycode Users	See above	See above
Timed Operation	Yes	Yes
Auto Lock/Auto Unlock	16 time schedules	limited fixed time schedules
Passage Mode	16 time schedules	Single time schedule
Time Shift User	16 time schedules	Single time schedule
Remote Access	Yes	Yes
Storehouse/Classroom Mode	Yes	Yes
One Time Use	Yes	Yes
iButton User	Yes	Yes
Permanent Code User	Yes	Yes
Remote Code User	Yes	Yes
One-Touch Lock from Inside	Yes	Yes
Daylight Saving	Yes	Yes
Lock Out Function	Yes	Yes
User Key Assignment Method	Software + Programming Key	Keypad
Software Package	Yes	(Optional)

Ordering Information

PART	DESCRIPTION
E4TKSC	E-4 TM + Keypad Satin Chrome Lockset Version
	OPTIONAL ACCESSORIES:
E-MT-L/R	Mortise Assembly (optional)
E4MMP	Mortise mounting plate kit (optional, used with E-MT-L/R)
K1977	DS1977 Programming Key (optional)
K1994	DS1904 Internal Clock Key (optional)
K1990	DS1990 iButton User Key (optional)
UIBPCR	iButton Reader ('Blue-Dot' PC encoder) (optional)
USBPCA	USB PC Adapter (optional)
ESWCD	Eternity Lock Management Software CD (optional)
FTUK	First Time User Kit (has USBPCA, UIBPCR, K1977)

Pack List:

1. Front Handle
2. Back Handle
3. Front Lock
4. Back Lock
5. Accessory Box
 - Standard Latch
 - Mechanical Lock Cylinder
 - Screws

MORTISE APPLICATIONS WITH THE ETERNITY 4 LOCK

NOTE: When ordering an E4 for a mortise application it is important to order the lock factory equipped for that use. The E4 lock must have shallow back mounting plates installed instead of the standard back plates as well as a longer power cable when used with the mortise latch. While it is possible to refit the shallow E4 back plates in the field, the standard power cable is very short and is soldered in place inside the lock. When carefully placed the standard cable will usually reach, but the installation is much more difficult. In addition, there are a number of small springs and pins that are likely to fall out of place when the back plates are interchanged. The original factory warranty will be void if a field retrofit is attempted on an E4 lock. If a retrofit to mortise use of an existing standard E4 lock is desired, contact Uaccess LLC technical support at 972-492-0752 for assistance.

Unlike the E4 itself, the mortise latch must be ordered either left or right handed. This refers to the swing direction and hinge locations of the door. If in doubt about which mortise type you need, contact your distributor or a factory representative for advice. While the E5 lock does not need modification for mortise use, like the E4 the mortise used must be ordered as either left or right handed. If in doubt as to which you need, contact your dealer or Uaccess LLC technical support at 972-820-6450

Mortise Lock 'Handed' Definitions

Door Swings In

Left Handed Mortise

Right Handed Mortise

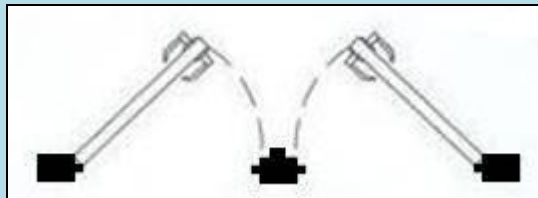

This side is Outside view of the door

(Keypad and iButton side of door)

Right Handed Mortise

Left Handed Mortise

Door Swings Out

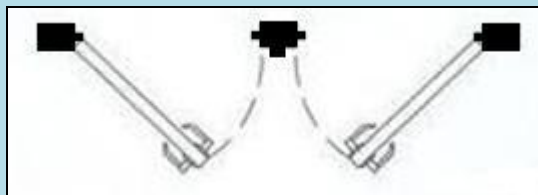

This side is Outside view of the door

(Keypad and iButton side of door)



Insert the mortise latch case into mortise pocket. Secure the lock case with two screws. If the mortise assembly has a wire harness attached, you may use wire cutters to remove it if desired. It is not used for this type of installation and may obstruct the mortise pocket.

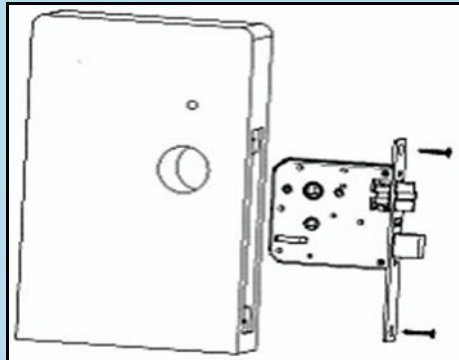

Mortise Spec

- 3/4" throw heavy duty deadbolt with anti-saw hardened pins
- Rustproof heavy duty 2 3/8" backset lock case
- Individual springs to prevent lever sag
- Forged brass lever handles exceed requirements of ADA
- Available in left or right hand versions
- Heavy Duty 1/2" latch bolt with anti-friction latch, easily reversible

Interconnected Deadbolt Mortise:

While unlocked turn the handle up to enable (lock) the deadbolt, or turn the handle down to disable (unlock) the deadbolt (E5 shown here)

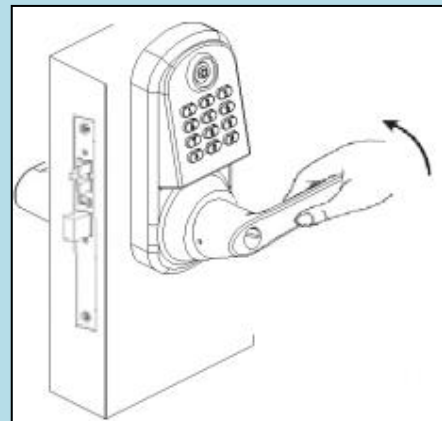

Standard (Non-Mortise applications) Door Prep

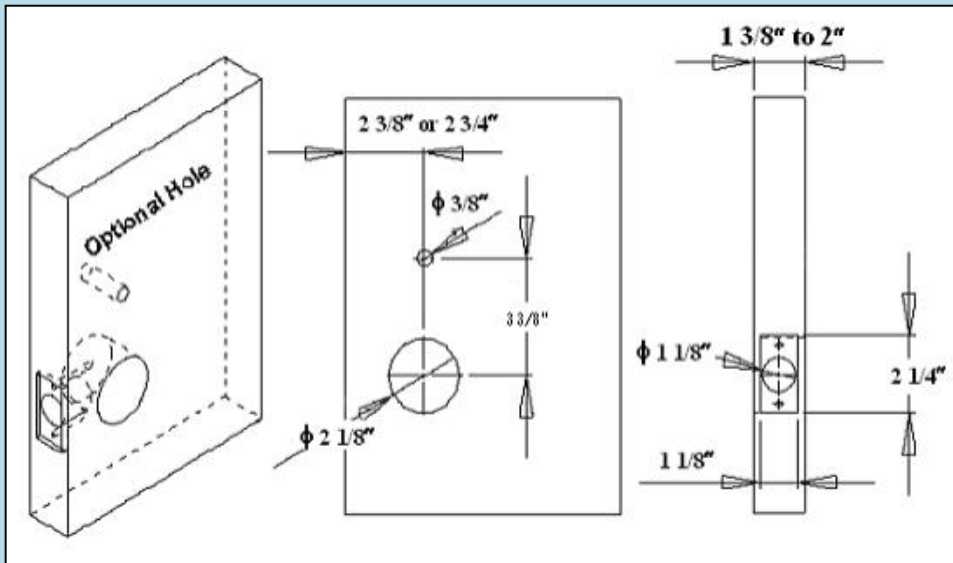

Distance between large hole center point and top of lock housing: 5 1/4"

Parts List

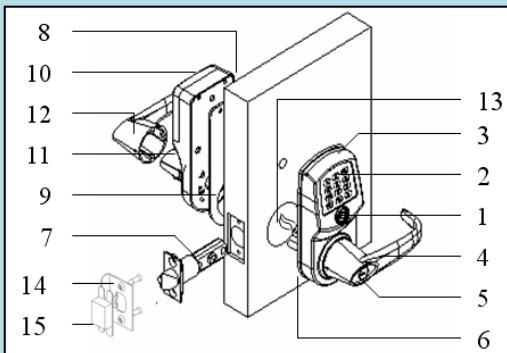
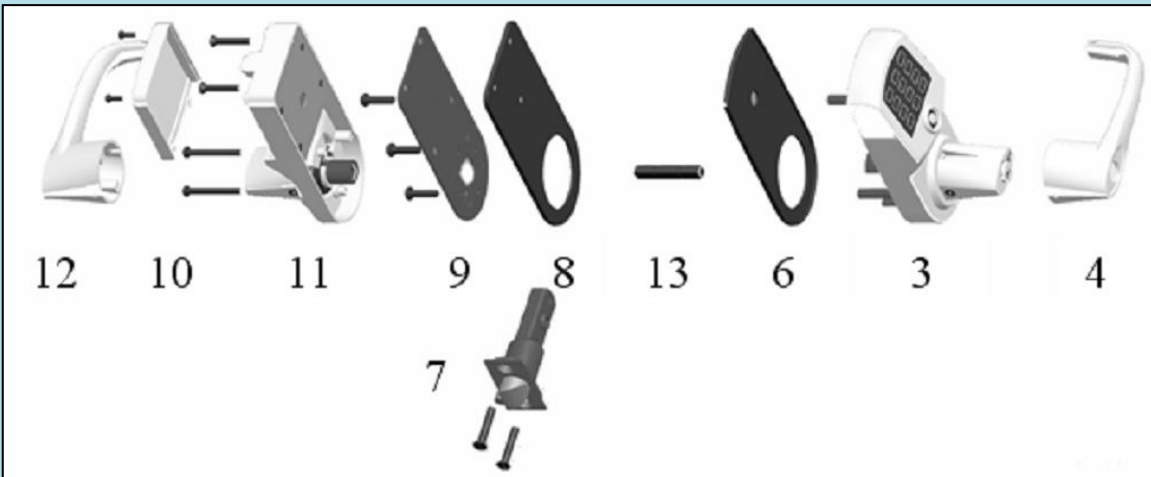

1	iButton Reader	9	Inside Mounting Plate
2	Keypad	10	Batteries Housing Cover
3	Outside Lock Housing	11	Inside Lock Housing
4	Outside Lever	12	Inside lever
5	Override Cylinder	13	Spindle (square bar)
6	Outside Gasket	14	Strike Plate
7	Latch	15	Dust Boot
8	Inside Gasket		

Eternity 4 Non-Mortise Installation Instruction

Step 1. Install the latch

- Insert the latch into 1" hole on edge of the door.
- Secure the latch in place with two screws.

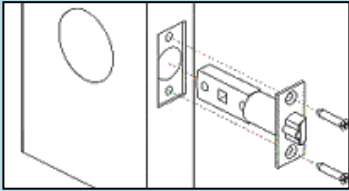

Fig. 1

Step 2. Install outside lock housing

- Place the outside gasket (if required) on back of the outside lock housing prior to the assembly; align the gasket along the edge of the lock housing.
- Insert the square spindle into the center hub and turn the spindle until the **Dot on center hub is point to left**. (If the dot is difficult to see, insert the square spindle into the center hub and turn the center hub to center it exactly in between the clockwise and counterclockwise stops.)

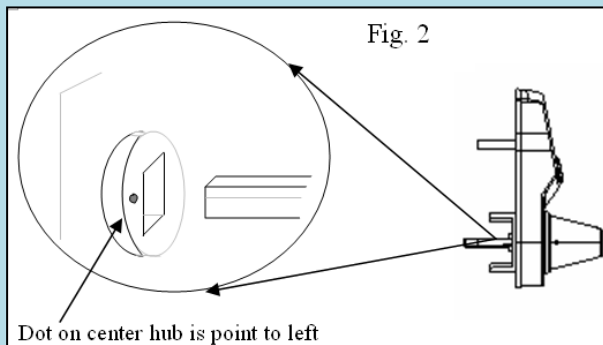

Fig. 2

- Place the outside lock housing against the door, feed the power plug through the 2 1/8 inch door hole.

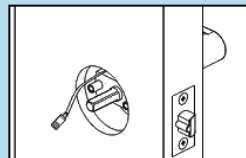

Fig. 3

Step 3. Install inside mounting plate

- Place the inside gasket (if required) on the mounting plate, and align the inside gasket with the position hole.
- Feed the power plug through the small rectangular hole on the mounting plate.
- Place the mounting plate against the door, and secure the mounting plate attach to outside lock housing with three screws.

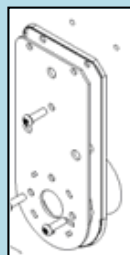

Fig. 4

Step 4. Install inside lock housing

- Plug the power cable into the inside lock housing.
- Place inside lock housing on top of the mounting plate,
- Ensure the square spindle into inside lever hub. Secure the inside lock housing with two screws.

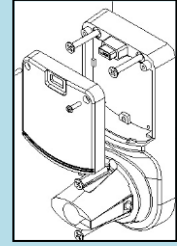

Fig. 5

Step 5. Install inside lever door handle.

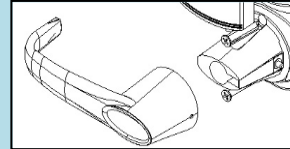

Fig. 6

Step 6. Install outside lever door handle

- Ensure override shaft inside the cylinder housing is in vertical position (use flat screw driver to adjust the position when needed)

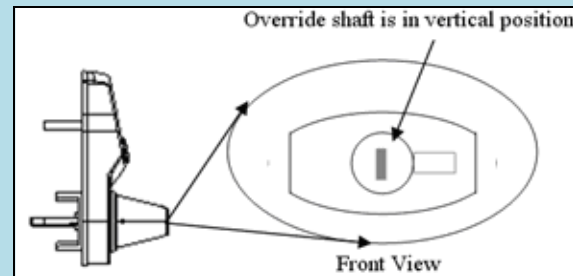

Fig. 7

- Place the key cylinder into the outside lever door handle, insert the manual key to the cylinder and turn clockwise 90 degrees. **Never disassemble the cylinder regardless of left or right handle use.**
- Guide the cylinder into the cylinder housing and snap the lever door handle into the lever catch pin
- Turn the manual key counter clockwise 90 degree and pull the key out

Step 7. Install Strike plate

- Inset the dust boot into the doorframe.
- Place the strike plate over the dust boot.
- Secure the plate in place with two screws.

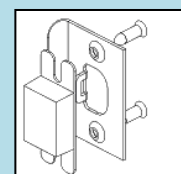

Fig. 8

IV. Eternity 5 Datasheet (Medium Duty keypad Lock)

Hardware Spec

PARAMETER	DETAIL
Weight (Lock only)	4.2 Lbs
Working Current	250 mA
Idle Current	15 μ A
Motor Running Time	0.4 Second
Working Voltage	4.8-6.4V
Low Battery Warning	4.8V – LED flashes after valid key used
Power Source	4 AA Alkaline Battery
Keypad	Weather Resistant Keypad
Handle	Left or Right handed
Door Thickness	1 3/8" to 2"
Keyway	SC 6 Pin
Dimension (1ps)	10 x 8 x 4 1/2"
Dimension (8pcs/box)	16 x 10 1/2 x 19"
Package Weight (1)	5 Lbs
Weight (8pcs/Box)	40 Lbs



Software Spec

Description	Software	Non-software
Audit Trail	Yes. 3,000+	No
Users	299	299
Timed Operation	Yes	Yes
Remote Access	Yes	No
Storehouse/Classroom Mode	Yes	Yes
One Time User	Yes	Yes
Software Package	Yes	No
Lock from Inside	No	No
Set Up Method	Software	Keypad
Daylight Saving	Yes	Yes
Lock Out Function	Yes	Yes

Regular Latch

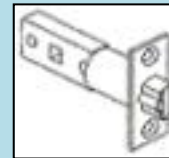

Mortise Latch

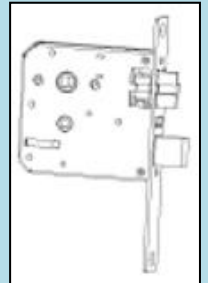

Mortise Spec

3/4" throw heavy duty deadbolt with anti-saw hardened pins
Rustproof heavy duty 2 3/8" backset lock case
Individual springs to prevent lever sag
Forged brass lever handles exceed requirements of ADA
Available in left or right hand versions
Heavy Duty 1/2" latch bolt with anti-friction latch, easily reversible
Interconnected Deadbolt Mortise:
While unlocked turn the handle up to enable (lock) the deadbolt, or turn the handle down to disable (unlock) the deadbolt (<i>E5 shown</i>)

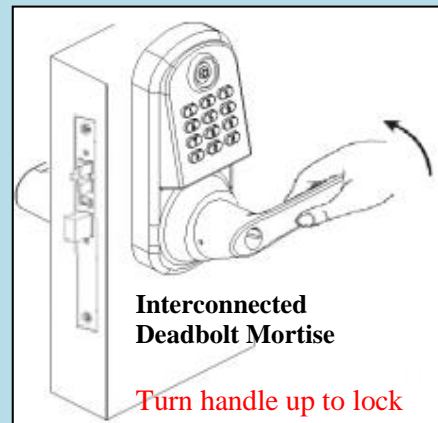

Ordering Information:

PART #	DESCRIPTION	PART #	DESCRIPTION
E5TKSCS	E5 Software Lock	K1977	iButton Programming Key
E5TKSC	E5 Non-Software Lock	K1904	iButton Clock Key
D-MC	Master Cylinder	K1990	iButton User Key
USBPCA/UIBPCR	USB 'Blue Dot' iButton Adapter	ESWCD	Software CD

Back View Installation

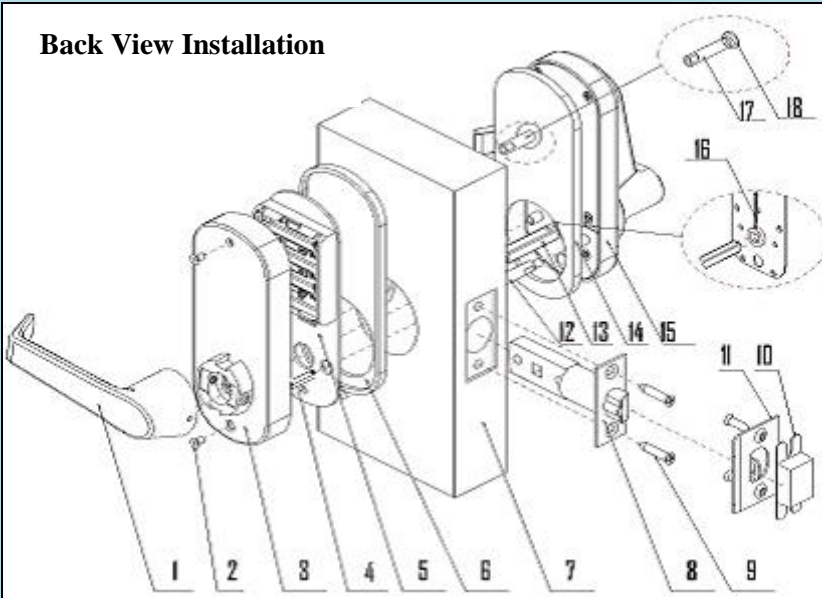

Major Lock Parts







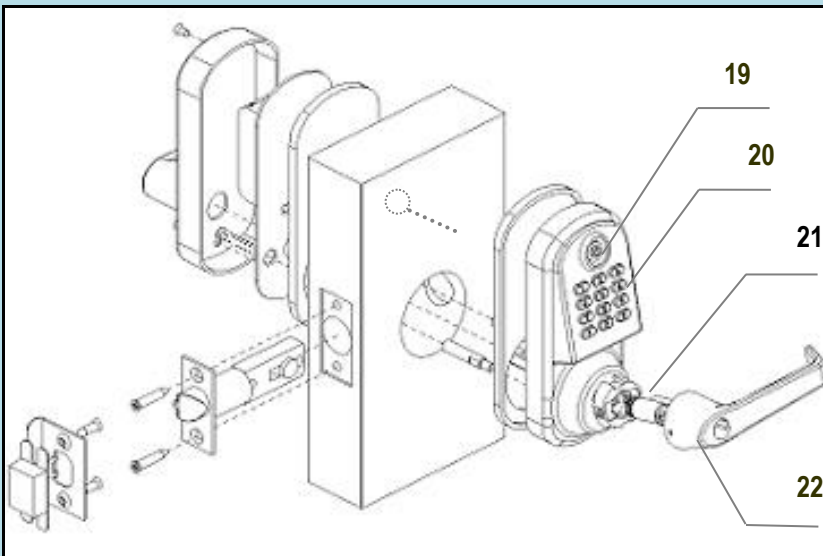

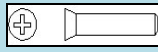

1. Rear Handle
2. Rear Lock housing Screws
3. Rear Housing
4. Battery Plate Screw
5. Battery Plate
6. Rear Rubber Gasket
7. Door
8. Latch
9. Latch Screws
10. Dust Boot
11. Strike Plate
12. Front Lock Fastener Post
13. Spindle (Square bar)
14. Front Rubber Gasket
15. Front Lock Housing
16. Cotter Pin
17. Upper Fastener Post (optional)
18. Attachment Screw (optional)
19. iButton Reader
20. Keypad
21. Override Key Cylinder
22. Front Handle

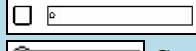
Distance between large hole center point to top of lock housing:
4 3/4"

Front View
Installation

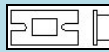

Accessory Parts List

1.  Battery Plate Screw (3)
2.  Back Cover Screw (2)
3.  Screws (4)
4.  Square Shaft (1)
5.  Cotter Pin (1)
6.  Fastener Extension (2)
7.  Upper Fastener Extension
8.  Latch (1)
9.  Strike Plate (1)
10.  Dust Boot (1)
11.  Override Key (2)
12.  SC4 Cylinder (1)
13.  iButton key (Optional)

Eternity 5 Installation

Step 1

Insert the latch into door hole. Secure the latch with two screws.

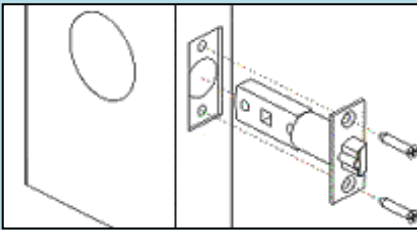

Step 2

Insert the square shaft (A) into the center hub (B) (Fig 1). Insert the cotter pin into the hole on the center hub to secure the square shaft. Bend the end of cotter pin around the center hub to secure the pin in place. (Fig 2)

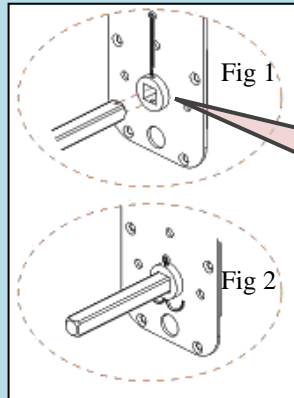

Enlarged
Fig 1

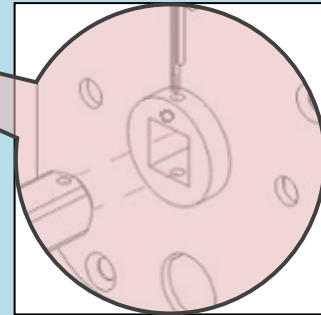

Step 3

Screw in and tighten the two fastener extensions (C) into the front lock fastener posts located on both side of the center hub. If desired, fasten and tighten the upper fastener extension (D) (Fig 3). Note: The upper fastener extension (D) to stabilize the lock is optional.

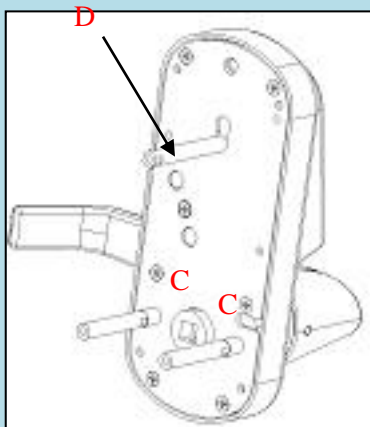

Fig 3

Step 4

Place the front lock housing onto the door, with the rubber gasket (E) between the door and lock housing. Feed the power plug (F) through the hole (Fig 4).

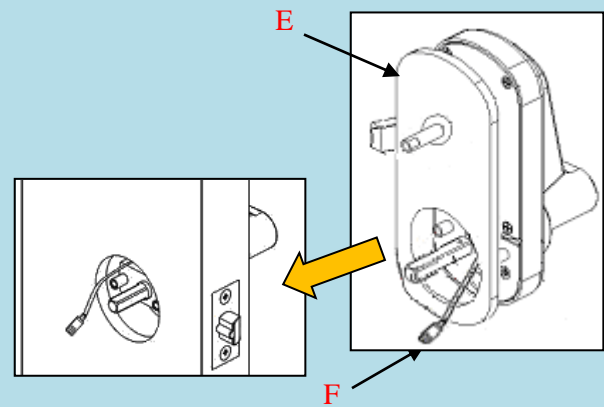

Fig 4

Step 5

Attach the battery plate onto the door, with the rubber gasket between the door and battery plate. Make sure the power plug goes through the small rectangular hole in the plate. Secure the battery plate to front lock fastener post with 2 screws. Fasten upper fastener post (Optional) (Fig 5)



Step 6

Install batteries, and plug in the power cable. Secure the back lock housing onto the battery plate. Fasten with 2 screws. Press both catch pins in and snap the rear handle into drive shift (Fig 6)

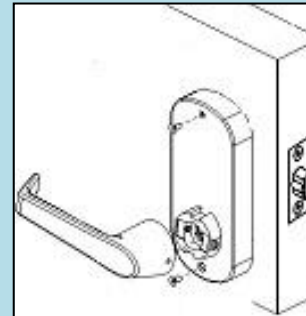

Fig 6

Step 7

Place the override lock cylinder into front handle housing, insert override key through the hole into cylinder. Turn the override key 90° clockwise. Press both catch pin in and snap the front handle into drive shift. Turn override key 90° counter clockwise and pull the key out. (Fig 7) **Never disassemble the cylinder, regardless of left or right handle use.**

Turn slot horizontal to install handle

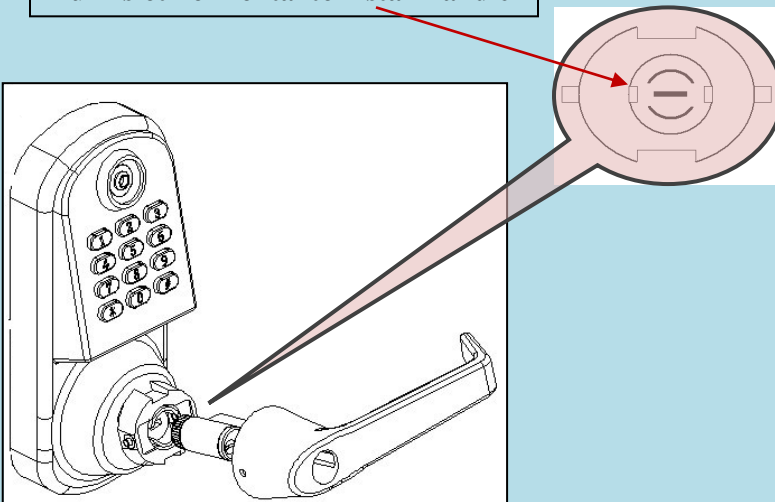

Fig 7

Step 8

Put strike box in doorframe, and then strike plate over it. (Fig 8)

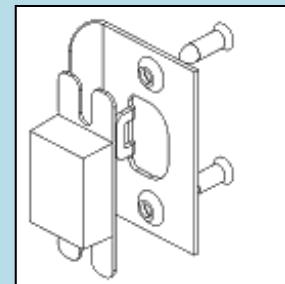

Fig 8

Eternity 5 Mortise-Installation

E5 locks require no internal disassembly for mortise use and can be field retrofitted with the mortise latch assemblies as long as the correct mortise kit and accessories are ordered and installed. The mortise latch itself must be ordered either left or right handed. This refers to the swing direction and hinge locations of the door. (See page 8) If in doubt about which mortise type you need, contact your distributor or a factory representative for advice.

Step 1

Insert the lock case into mortise pocket. Secure the lock case with two screws. If the mortise assembly has a wire harness attached, use wire cutters to remove it if in the way. It is not used for this type installation.

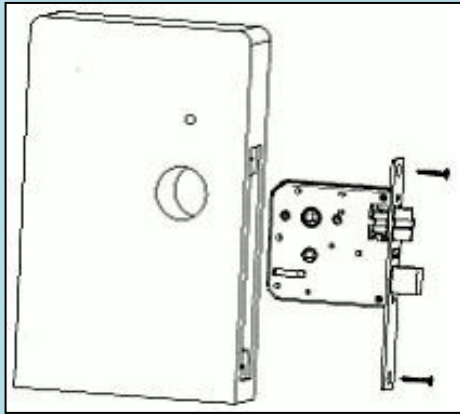

Step 2

Insert the square shaft (A) into the center hub (B). (Fig 1)
Insert the cotter pin into the hole on the center hub to secure the square shaft. Bend the ends of the cotter pin around the center hub to secure the pin in place. (Fig 2)

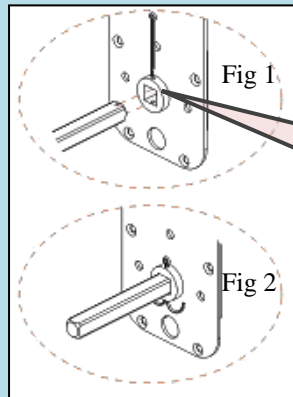

Enlarged
Fig 1

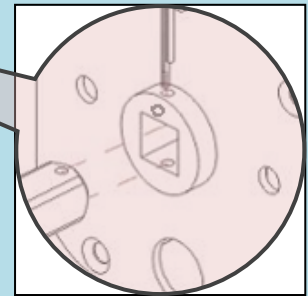

Step 3

Screw in and tighten the two fastener extensions (C) into the front lock fastener posts, located on both side of the center hub. Attach and tighten the upper fastener extension (D) (Fig 3) Note: The upper fastener extension (D) is optional.

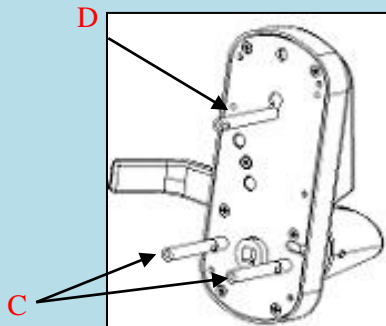

Fig 3

Step 4

Place the front lock housing onto the door, with the rubber gasket (E) between the door and lock housing. Feed the power plug (F) through the hole (Fig 4).

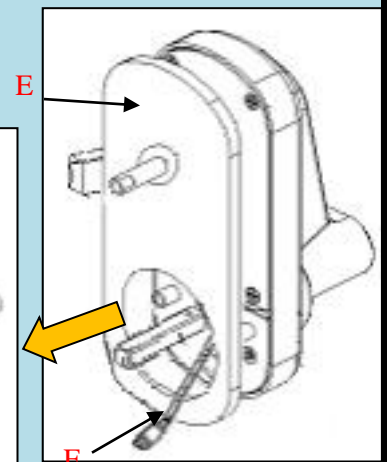
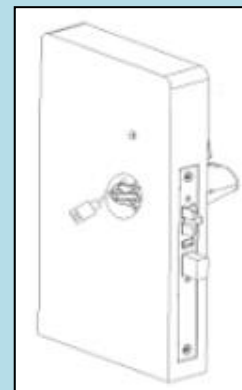

Fig 4

Step 5

Attach the battery plate onto the door, with the rubber gasket between the door and battery plate. Make sure the power plug goes through the small rectangular hole on the plate. Secure the battery plate with 2 screws, or 3 screws if you have installed the optional upper fastener extension post. (Fig 5)

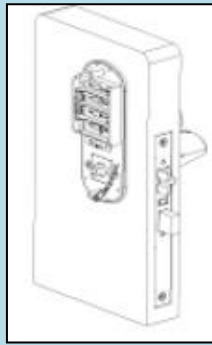

Fig 5

Step 6

Install batteries, and plug in the power cable. Secure the back lock housing onto the battery plate. Fasten with 2 screws. Press both catch pins in and snap the rear handle into drive shift (Fig 6)

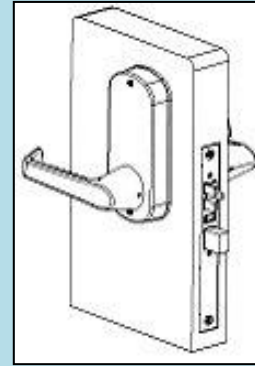

Fig 6

Step 7

Place the override lock cylinder into front handle housing, insert override key through the hole into cylinder. Turn the override key 90° clockwise. Press both catch pin in and snap the front handle into drive shift. Turn override key 90° counter clockwise and pull the key out. (Fig 7) **Never disassemble the cylinder, regardless of left or right handle use.**

Turn the slot horizontal to install handle

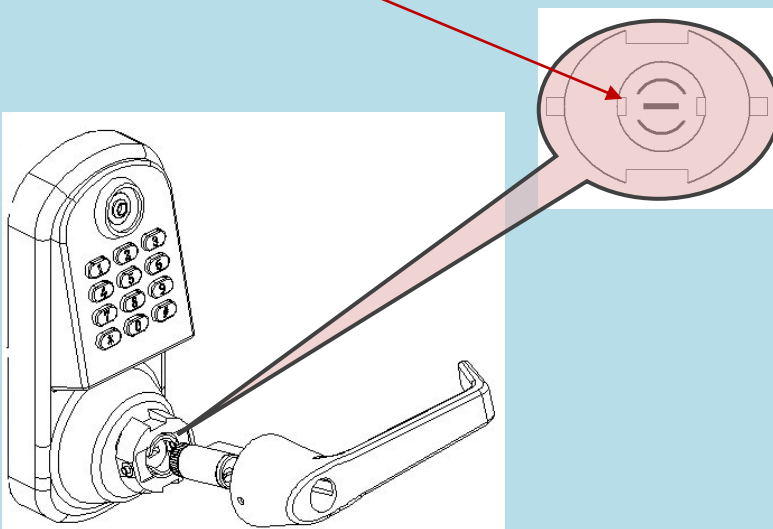

Fig 7

Step 8

Install the dust boot with strike plate onto it. (Fig 8)

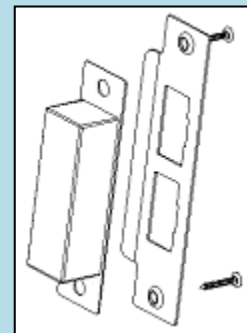
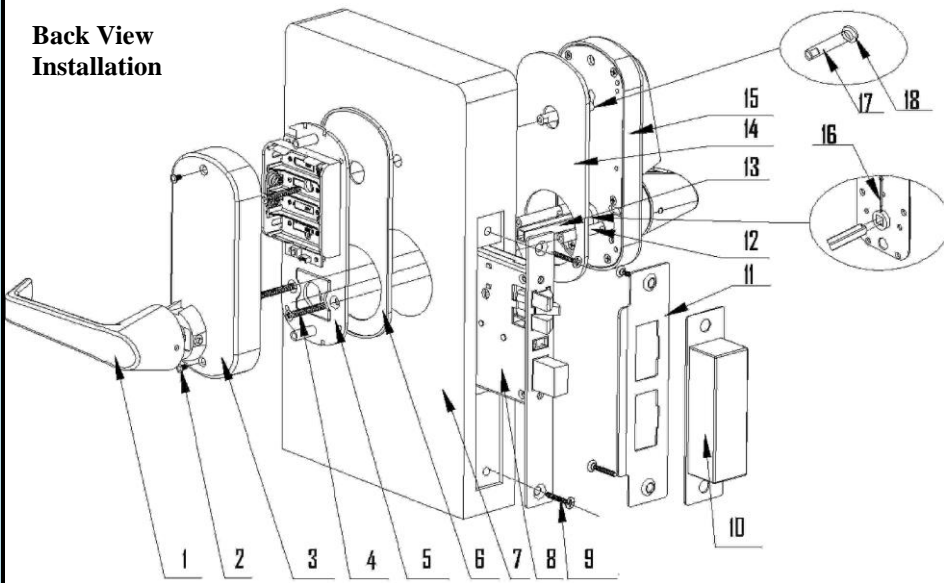

Fig 8

**Back View
Installation**



Major Lock Parts

1. Rear Handle
2. Rear Lock housing Screws
3. Rear Housing
4. Battery Plate Screw
5. Battery Plate
6. Rear Rubber Gasket
7. Door
8. Latch case (Mortise)
9. Latch Screws
10. Dust Boot
11. Strike Plate
12. Front Lock Fastener Post
13. Square Shaft
14. Front Rubber Gasket
15. Front Lock Housing
16. Cotter Pin
17. Upper Fastener Post (optional)
18. Attachment Screw (optional)
19. iButton Reader
20. Keypad
21. Override Key Cylinder
22. Front Handle

**Front View
Installation**

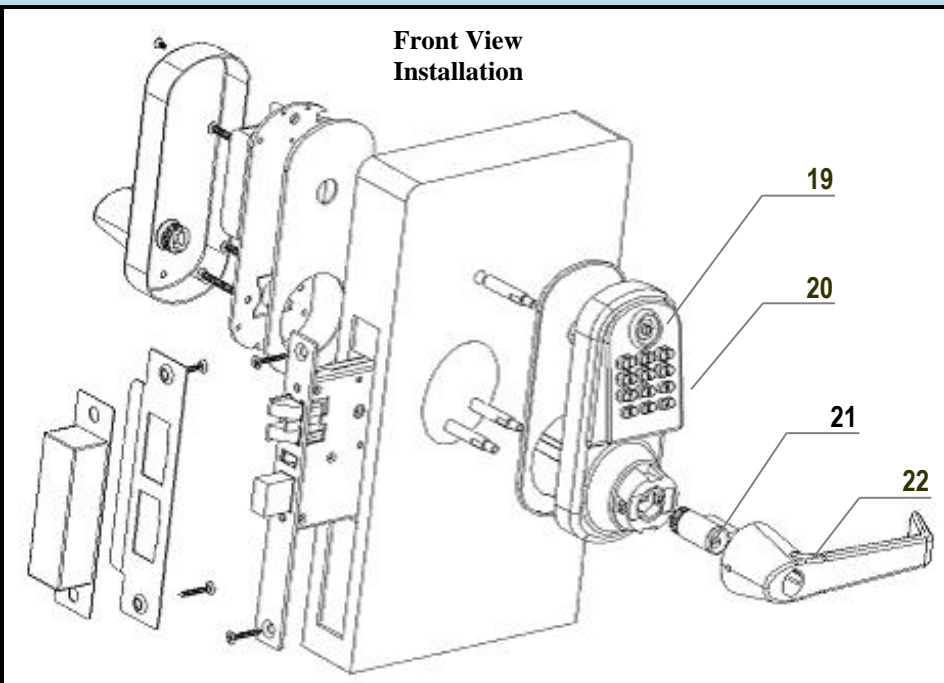

Accessory Parts List

1. Battery Plate Screw (3)
2. Back Cover Screw (2)
3. Screws (4)
4. Square Shaft (1)
5. Cotter Pin (1)
6. Fastener Extension (2)
7. Upper Fastener Extension
8. Mortise (1)
9. Strike Plate (1)
10. Dust Boot (1)
11. Override Key (2)
12. SC4 Cylinder (1)
13. Allan Wrench (1) (Optional)
14. Allan Screws (2) (Optional)
15. iButton key (Optional)

Section 2 - Eternity 3.7 Software Guide

Revision 10/3/2018

1. Software Setup

The Eternity PC Software works the same for both Eternity 4, Eternity 5 E5TKSCS, E5TKSBS, Eternity 2 E2TMKP, and EDC700 series door controller systems. (E2TMKP and EDC700 have differences in reset button processes for new lock setup but are otherwise much the same.)

Note: *E5 models E5RFKSC, E5TKSB, E5TKSC cannot be programmed using PC software. E5TKSB and E5TKSC can be returned to the Uaccess LLC and be upgraded for use with the PC software at customer expense.*

Operating System

Eternity 3.7 software is compatible with Microsoft Windows 2000/XP/Vista/Win7. All software must be installed using Windows administrator account, but all level Windows users can use the program. Failure to install the applications may result in error messages and an incomplete installation. For Vista/Win7 users, you may need to run the application each time as an administrator.

Installing 1-Wire USB Driver First



1. Insert installation CD. Note: On most computers, the Autorun program should launch automatically. If it does not, select *Start/Run*, browse to CD-ROM drive, select the *Autorun file*.
2. Select *1-Wire USB Driver Installation*, the Setup Wizard will guide you through the steps.
3. The *License Agreement* screen displays.
4. Select *I Agree*, and then *Install to start installation*.
5. Select *Finish*. The 1-Wire USB Driver Installation is complete.
6. Plug the 1-Wire USB device into the USB port on your computer
7. **Check the time and date on your computer and correct if needed.** The time and date in your computer is used to set the clock in the locks, so any errors in the PC time will also be loaded into the locks.

Installing the iKeypad Software

1. Select Eternity Software Installation. The Auto installer will guide you through the steps and create the shortcut – “iKeypad” on your desktop.
2. Select *Next* until the installation finishes.

Starting the iKeypad Software



Start the program by clicking on the desktop Icon for the iKeypad software.

Program Login: User Name and Password

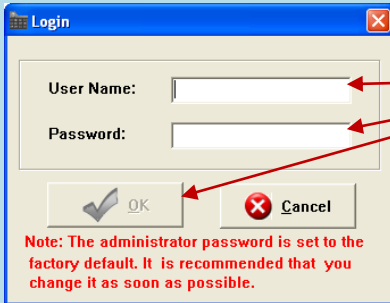

User Name:

Password:

OK Cancel

Note: The administrator password is set to the factory default. It is recommended that you change it as soon as possible.

Enter the default user name 'dallas' and the default password 'ibutton' and click 'OK' to start the program the first time. (All lower case)

Changing / Adding Users and Passwords

The default user password can be modified but can't be deleted. You may however add additional users and/or modify existing user passwords by selecting 'Other' from the top of the menu, then 'Operator Information' and 'Change Operator' or 'Change operator Password' selections from the upper set of main menu tabs.



Note: (In order to apply a particular password to a **new** operator, select 'Change Operator Password' and enter the default **new** operator password of '00000000'. (8 zeros) You may then enter the new password for that operator.)

Changing the System Facility Code

The default system facility code is 000000 (6 Zeros). IT IS MANDATORY TO CHANGE AND REMEMBER THE FACILITY SYSTEM CODE ENTERED WHEN THE USER IS READY TO **FIRST** USE THIS SOFTWARE. This is **NOT** a user password. It allows the locks to respond only to your particular software, not someone else who might have a different copy of the same software. (For security purposes.) Other copies of this program cannot access locks that have been programmed using a different facility code unless the locks have been completely reset to factory new conditions first as a security measure. (*Failure to remember what the facility code becomes may make future computer 'backups' of the software not function with the locks.*) The PC software facility code can also be later changed via the 'Other', then 'System Configuration' menus. **THIS IS STRONGLY DISCOURAGED ONCE THE DEFAULT FACILITY CODE IS CHANGED DURING INITIAL SOFTWARE SETUP AND INITIAL NEW LOCK PROGRAMMING**, as this will make the software unable to address locks that were set up using the original facility code.



Enter '000000' in the space for the 'Old Facility Code'. Then enter your choice for a new Facility code in the space provided. The code must be a 6 digits long (numbers only) but can be any number from 000001-999999. After entering the selections click on 'OK'.

2. Access Control Management

I. Lock Setup

New Lock Set Up Overview:

- Initialize the lock back to the manufacture default settings.
- Sets the facility security code and current time and date into the lock.
- Set the lock clock to enable or disable the Daylight Saving time functions
- Set the default Lock Mode to 'Classroom' Mode (sometimes also called 'Passage' mode) or 'Storehouse' Mode .
- Set LED Blinking about once every 10 seconds, or off for better battery life.

Steps to set up a new lock:

1. Connect the USB blue dot receptor to the computer USB port.
2. Login to the software.
3. Snap the program key (DS1977) onto the USB blue dot receptor, and Click 'Lock Management'
4. Click on 'Setup New Lock' from the drop-down menu (See above). Select the default options you want by clicking on the check boxes provided.
5. Select 'Issue Key' from the bottom of the menu, and answer 'OK' to any popup warnings.
6. Hold the reset button on the lock until there are two beeps and a solid green light; when the LED starts blinking green, release the reset button and immediately press the # key. When the lock stops flashing and beeps 3 times, the lock has been reset to factory defaults.
7. Press the reset button once quickly and release it. The lock will light the LED green and beep twice.
8. **While the LED is still lit**, touch the program key to the iButton reader on the lock. There will be two more beeps to indicate that the lock confirmed the information upload from the program key. The lock will now have been initialized and the lock will have recorded its lock identification number on the program key.



Click 'Lock Management', then 'Setup New Lock' from the drop-down menu.

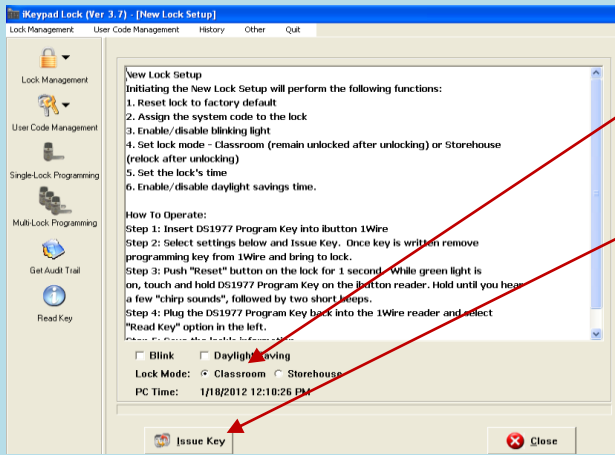

Select the default options you want by clicking on the check boxes provided.

Select 'Issue Key' from the bottom of the menu, and answer 'OK' to any popup warnings. Use the program key on the lock reader following steps 6-8 above.

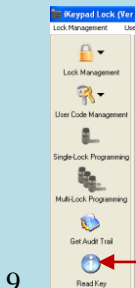

Snap the program key back onto the USB blue dot receptor, and click the "Read Key" icon.

9.

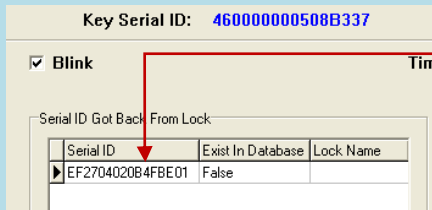

The new lock id number will appear in the retrieve window

10.

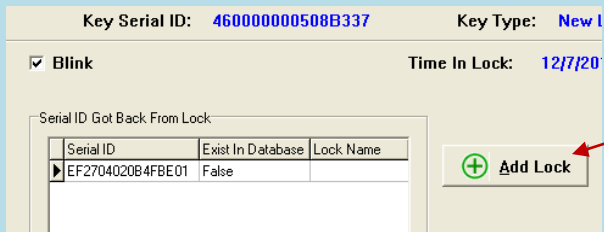

Click on the 'Add Lock icon'

11.

Note: If the lock already exists in the system, the "Exist in Database" will show "True". You cannot add the same lock to the system again without first deleting it from the PC program database. **No lock can have duplicate records in the PC software.**

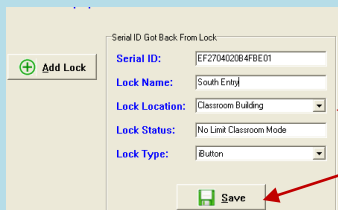

Type in a lock name, location, and the lock type, then click the 'Save' button.

An Alternative way to enter *existing* locks to the system:

Overview

Selecting the 'Lock Management' icon on the main menu, then clicking on the 'Lock Setting' from the drop-down menu is an alternative way to add existing locks to the system *if you already have initialized them using the same Facility Code at some point, and have the lock ID number*, but have a need to manually enter them again. We recommend users keep the lock ID on file after the new lock setup so that you can manually input a lock profile into the system if ever needed. (You cannot change the user assignments from the 'Lock Setting' screen. User assignments to a given lock are made through the 'User Code Management' screen.)

Select the 'Lock Management' icon on the main menu, then clicking on the 'Lock Setting' from the drop-down menu

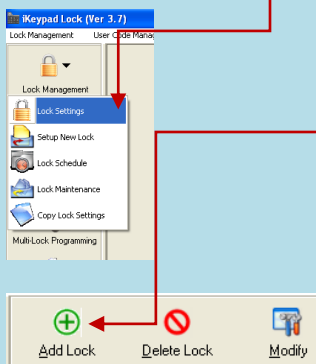

Select the 'Add Lock' icon from the top of the screen.

Enter the serial ID number for the lock you wish to manually add, along with any desired Status, Lock Type, Lock Name, and Lock Location information. When completed, select the 'Save' icon.

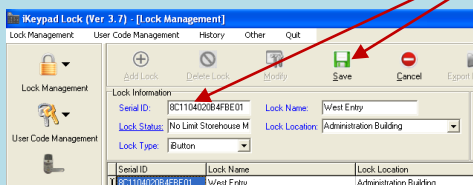

Editing (modifying) existing lock information or configuration



Select the 'Lock Management' icon on the main menu, then clicking on the 'Lock Setting' from the drop-down menu

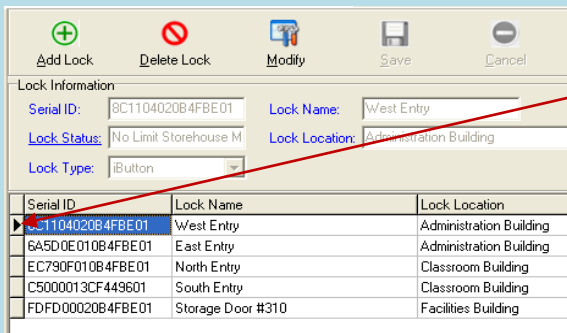

To modify a lock, select the lock you wish to modify by clicking on that lock entry.

Click the 'Modify' button.

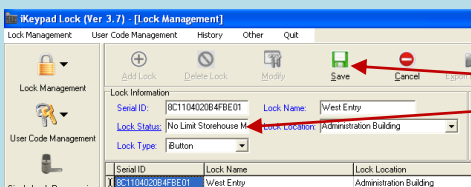

Click on the entries you wish to change, modify the data, then click on the 'Save' icon. If the 'Lock Status' or 'Lock Type' are modified, either 'Single Lock' or 'Multilock' programming of the lock *must* be done before the lock function will change.

II. User Setup

Setting User Access codes and/or iButtons

Overview:

- Add/Edit user information
- Select 'User Code Management' from the main menu. Select 'User Settings' from the drop down menu.
- To add an iButton / key code user, click “Add User” button in the key setting menu (or 'Modify' if you wish to change an existing user)
- For new users, enter the name information, and if desired the 'Title', 'Department' and 'To add iButton user, click ok and snap a user iButton key into the USB blue dot receptor. Click on the empty field of “Serial ID”, the iButton key ID will be detected by the system and automatically entered.
- To add key pad code user, check the “Key Code User” and click 'OK'. Type in user code under Key Code field. If the either user key type or name already exists in the system, the software will pop up a warning.
- To enter a 'Complex' user (Requires that the user use **BOTH an iButton AND a keypad code every time for extra security**) click on "Complex User, then 'OK'.

For any of the three user types, enter the user profile as follows:

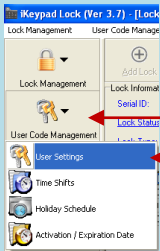

Select 'User Code Management' from the main menu. Select 'User Settings' from the drop down menu.

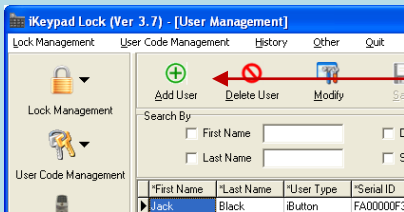

To add an iButton / key code user, click “Add User” button in the key setting menu

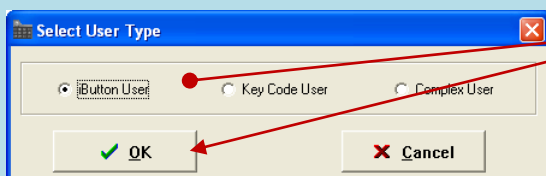

Select the user type you desire, then click on 'OK'

Enter the specific user information:

- **First name:** Input the first name of the key owner.
- **Last name:** Input the last name of the key owner.
- **Status:** Active or Inactive User (reserve for future use).
- **Department:** User can input a new name in the field. The new name will be saved to the Department list once the data saved. (Not a required data entry.)
- **Title, address:** Can be entered as the key owner profile. (Not a required data entry.)

Enter user names, department, title, and address

*First Name	*Last Name	*User Type	*Serial ID	*Key Code	*Status	Department	Title	Address
Jack	Black	iButton	FA00000F3048B001		Active	Math	Professor	4321 Green Street
Wayne	Jones	Complex	670000002903F701	1955	Active	Registration	Data Entry	5920 Green Street
Mary	Martin	iButton	5E000000451E0401		Active	Accounting	CPA	7654 Main Street
Frank	Phillips	iButton	AD000000DE8C0201		Active	Maintance	Grounds Keepin	9128 Gray Street
John	Smith	iButton	4B0022336F26F001		Active	English	Professor	1234 West Street
William 2	Wright	KeyCode		7752	Active	Personel	HR	6667 State Street
William	Wright	iButton	7500000077CFF301		Active	Personel	HR	6667 State Street
*		iButton			Active			

Note: No duplicate keys or user names are allowed in one system. If one particular user needs to use either a keypad code OR an ibutton code, to avoid using a duplicate name a different spelling or using a number with the name will allow for this, as the example shown above illustrates.

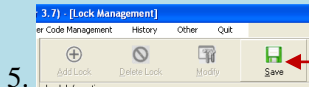

5.

After entering each desired user, click "Save" button and that user's keys/codes will be stored.

Assigning Users to a Single Lock

Overview:

This menu is used to assign iButton keys and user codes to one lock.

- Select lock from lock name list
- Change Time Shift, Activation / Expiration, or Holiday (Exception) settings to be assigned to the lock
- Click on the 'Selected' column to assign users you desire for the lock
- Snap in DS1977 programming key into the USB blue dot receptor
- Click 'Issue Key'
- Complete the lock programming by touching the programming key to the target lock reader until you hear a double beep.

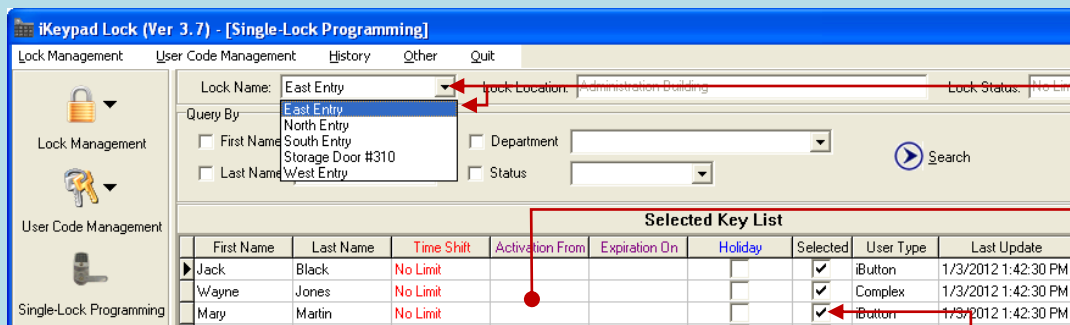

Select the desired lock from the pull-down Lock Name list

Change the 'Time Shift', 'Activation', 'Expiration', or 'Holiday' group assignments for each user if or as desired

Click to the 'Selected' Column box for each user you desire assigned to the lock

Click the 'Issue Key' at the bottom of the

Multiple Lock Assignment

Overview:

This process is to assign a key list to multiple locks at one time. Up to 8 locks can be assigned to each programming key, with a maximum of 114 keys total. The process is similar to single lock programming, but allows limited programming of multiple locks without returning the DS1977 program key to the USB blue dot receptor between each lock. The limited memory available in the DS1977 key means that you may have to use 'Single Lock' programming to pass the time schedules database *tables* to the locks if they have been changed. The data *tables* of all the available 'Time Shift', 'Holiday', 'Activation', and 'Expiration' are only passed to locks during 'Single Lock' programming process. As long as that data hasn't changed, you may assign these **already** existing time-group *tables* to locks and users using the 'Multi-Lock' programming menu as desired.

To use Multi-lock Programming:



Click the 'Multi-Lock Programming' Icon

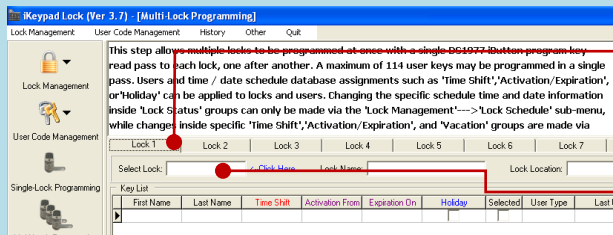

Click on the tab of the lock number you wish to configure

Click on the 'Select Lock' data entry spot to open the lock selection menu.



Click on 'Search' to list the specific locks available to program.

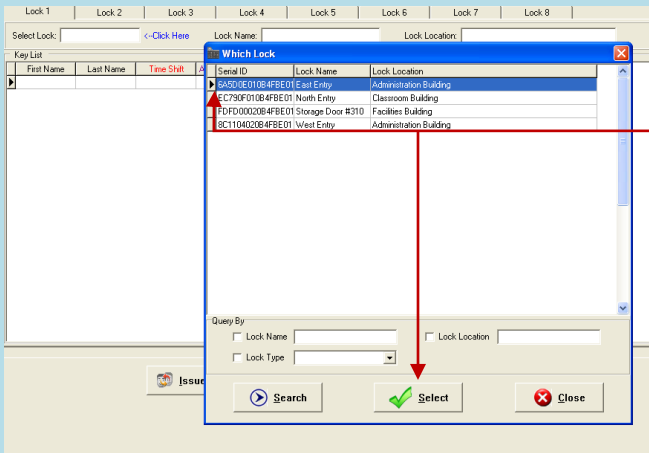

Click on the specific lock you want to have as 'Lock 1', then click on 'Select'

First Name	Last Name	Time Shift	Activation From	Expiration On	Holiday	Selected	User Type	Last Update
Jack	Black	No Limit				<input checked="" type="checkbox"/>	Admin	1/3/2012 1:42:30 PM
Wayne	Jones	No Limit				<input checked="" type="checkbox"/>	Complex	1/3/2012 1:42:30 PM
Mary	Martin	No Limit				<input checked="" type="checkbox"/>	Button	1/3/2012 1:42:30 PM
Frank	Phillips	No Limit				<input checked="" type="checkbox"/>	Button	1/3/2012 1:42:30 PM
John	Smith	No Limit				<input checked="" type="checkbox"/>	Button	1/3/2012 1:42:30 PM
William 2	Wright	No Limit				<input checked="" type="checkbox"/>	KeyCode	1/3/2012 1:42:30 PM
William	Wright	No Limit				<input checked="" type="checkbox"/>	Button	1/3/2012 1:42:30 PM

Assign users to the particular lock by checking the 'Selected' data box for the desired users as well as assigning 'Time Shift', Activate/Expiration, and Holiday groups in the same manner as in 'Single Lock' programming.

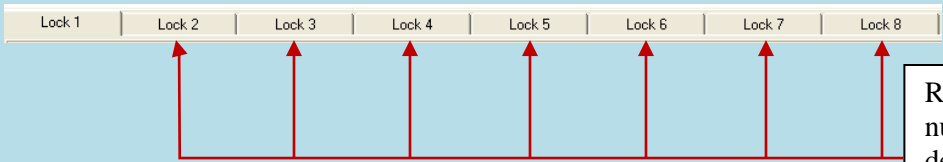

Repeat this series of processes to assign lock number, users, and other settings to the desired locks. Up to 8 locks can be programmed at once using the 'lock 1-8' tabs in the 'Multi-lock' menu.

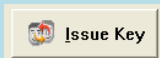

When all the desired locks and user configurations have been entered, snap the DS1977 program key into the USB blue dot receptor and click on 'Issue Key'

- Take the DS1977 program key and touch it to the reader of each of the target locks. There is no need to return the program key to the PC in between every lock. Hold the key to each lock until the chirping noise stops and the lock beeps twice.
- The order in which the locks are programmed does not matter. A maximum 114 keys can be assigned (total) at one time using Multi-Lock programming.

Copy Lock Setting

Overview:

This is a very useful tool when multiple locks have identical setting such as key list and/or timetable. After enrolling all the locks and users into the system, assign timetables and assign user keys/codes to one lock, then use this lock as model lock.

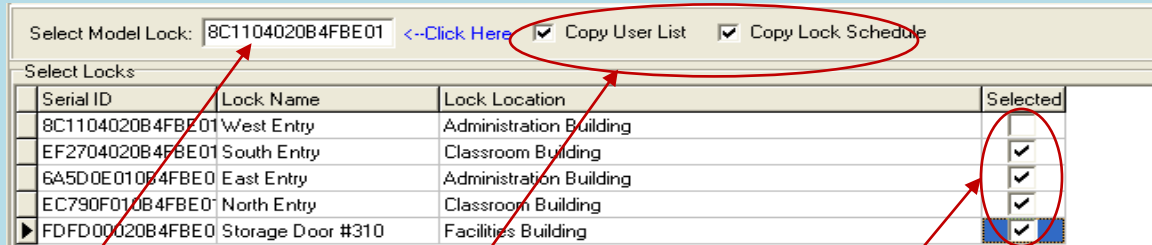

Step1: Click here to select 'model' lock from the popup lock list

Step2: Select "Same Key List" or/and "Same Time Table" to be copied

Step3: Select the locks to copy TO from the list

- Double click on the field of "Select Model Lock", and select the lock from the pop up screen.
- Check the "Selected" boxes and issue the program key using the USB blue dot receptor.
- Complete the process by touching the programming key to each of the selected lock readers and hear the double beep conformation from each lock.

3. Advanced access control Management

III. Time Schedule Settings

Time shift, activation/expiration, and exception date settings can be applied by using the 'Time Shift', 'Holiday Schedule', and the 'Activation / Expiration' menus to set the time periods you want, then by selecting the desired timing groups during later key assignments to locks with 'Single Lock Programming' or 'Multilock Programming'.

Time Shift Setting

This function is used to set the restricted time period(s) for user keys, which prevents unauthorized or unwanted personnel from entering the facility during off-hours. The beginning time and ending time of each days period can be added based on user group's permission. There are 16 Time Shift Groups in total and up to 7 settings in each group. (This can allow for different schedules for each day if you wish)

The first group is 'No Limit'. This is a default setting for each new key and this group cannot be modified. Other groups can be modified and assigned if the 'No Limit' group is not what is desired.

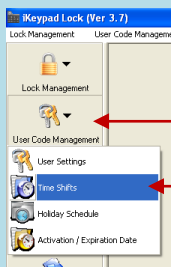

Select 'User Code Management' from the left side icon, then click on 'Time Shifts' from the drop-down menu

To add or modify each time period in a time group:

- ✓ Select the group number you want from the left side window, then click on Add, Modify, or Delete button to edit the settings in the right side window. (Group 1, 'No Limit', is the default and cannot itself be modified.)

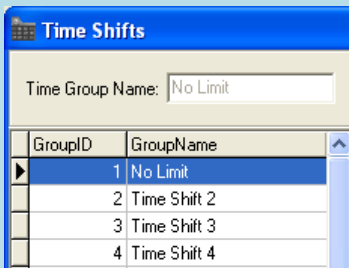

Here is the example for Time Shift Group 2:

A company wants to set the Group 2 Shift to have access from Monday to Friday 8:00am to 5:00pm, and no access allowed on Saturday and Sunday. Select 'Add', then set the beginning, end, and day of week you desire. Select 'Save' after each of the groups you are entering.

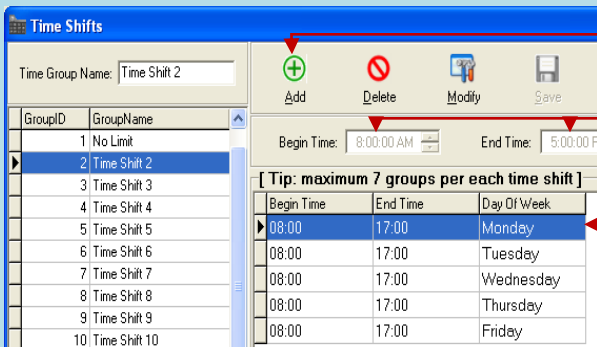

Select 'Add'

Set the beginning time, end time, and the day of the week as you desire.

Select 'Save' after completing each of the day groups you are entering. Each 'Time Shift' group can have up to 7 days or times.

- Once all the setting(s) desired are entered and saved, click the 'Quit' button to return to the previous menu.

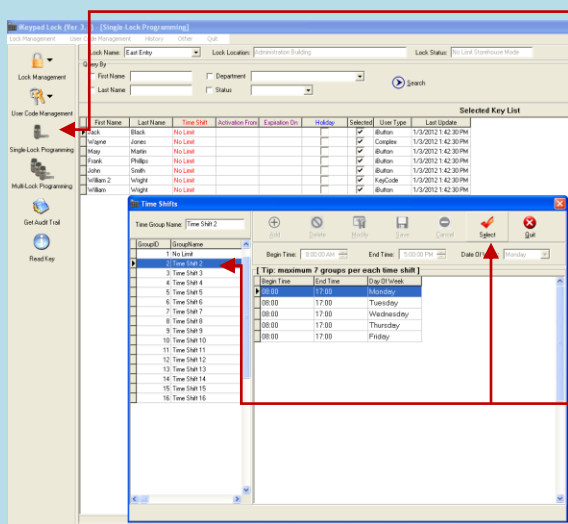

Use the 'Single Lock' or 'Multi-Lock' programming menus and select which 'Time Shift' group you want assigned to a particular user(s) by clicking on that user(s) 'Time Shift' listing.

A menu will popup allowing you to select which *existing* time shift group you wish to use. Click on the desired time shift, then the 'Select' icon at the top of the screen.

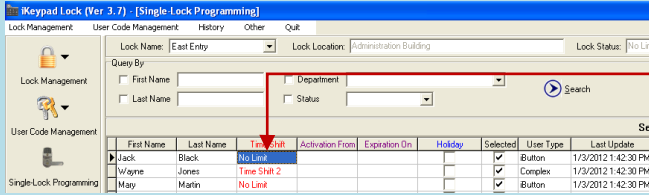

The 'Time Shift selected has been applied.

Remember: You must complete Single lock, Multi-lock, or Copy Lock programming steps to then write the new schedule databases into the lock(s) by using the USB blue dot receptor and the DS1977 programming key to create the key to program the lock(s) themselves.

Lock Time Scheduled Operation Setting

Overview:

This function is used to set the lock automatically unlocked, locked, storehouse mode, or classroom mode at the desired time. The schedules of various automatic operations of the lock(s) are entered into groups in the 'Lock Schedule' menu, found by clicking on the 'Lock Management' menu icon and selecting 'Lock Schedule'.

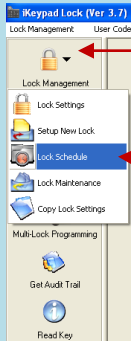

Click on the 'Lock Management' menu icon and select 'Lock Schedule'

There are 16 Timed Operation Groups in total, and up to 16 settings in each group. The first setting by default is No Limit Classroom Mode (The lock will stay at Classroom (Passage) mode all the time.) The second setting by default is No Limit Storehouse Mode (the lock will, at all times, relock automatically shortly after the user unlocks the lock). Any particular lock may only have one **group schedule** assigned to it at a time, but conversely one group can be assigned to as many locks as you may desire. *The time tables for lock schedules are set here, but not assigned to specific locks in this menu.*

There are 4 basic types of lock actions you can schedule by day and time, and by lock:

- Storehouse Mode: In this mode, the lock will lock back in a few seconds (0.1-25.5 seconds).
- Classroom Mode: In this mode, the lock does not lock back. The use of a valid iButton or code simply makes the lock go from unlocked to locked or locked to unlocked.
- Lock Mode: In this mode, the lock will automatically lock at the setting time.
- Unlock Mode: In this mode, the lock will automatically unlock at the setting time.

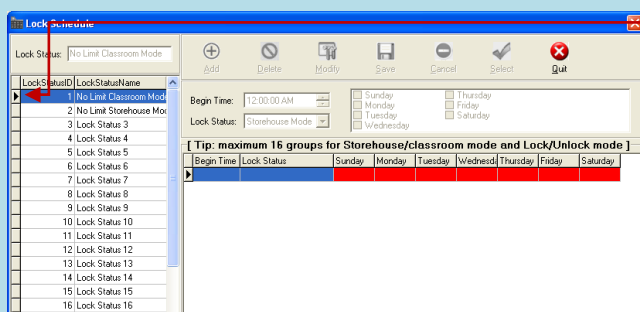

Start by clicking on a lock status ID to set up or an existing one to modify

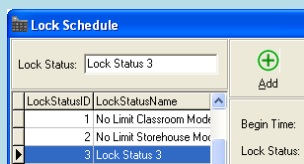

Click on 'Add'



Select the 'Lock Status' you wish to schedule from the drop-down menu

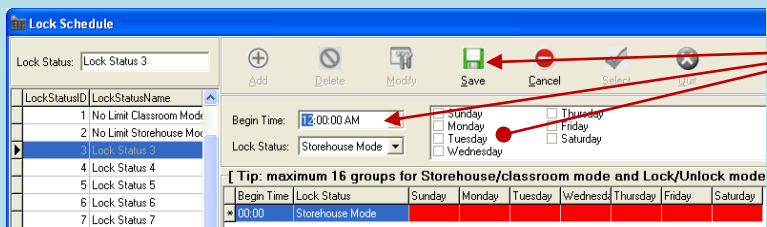

Set the Time and days you want for the scheduled lock status change you want, then click the 'Save' icon.

Repeat this process until the entire schedule you want is listed for that Lock Status ID has been entered, then select the 'Quit' icon from the top of the screen.

Assigning a particular Status schedule group to a particular lock

Overview: The automatically timed operation settings are applied to individual locks via the 'Lock Management' → "Lock Setting" menu by first selecting the lock you wish to apply the schedule group to, using the 'Modify' icon at the top of the menu, then changing the "Lock Status" section to match the schedule you want.

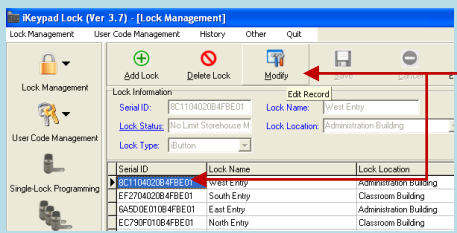

Select the lock you desire to apply a schedule to, then click on the 'Modify' icon

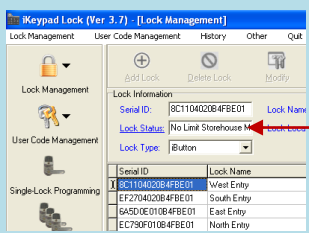

Click on 'Lock Status'. This will open the 'Lock Schedule' window.

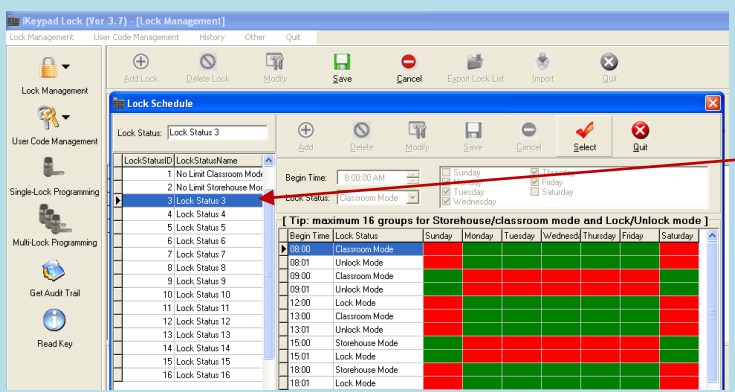

Select the existing 'Lock Status' group you want to apply to the lock. You cannot modify an *existing* group from this screen, only select the group itself. (To change the scheduled events *IN* a group, you must use the 'Lock Management' → 'Lock Schedule' menu.)

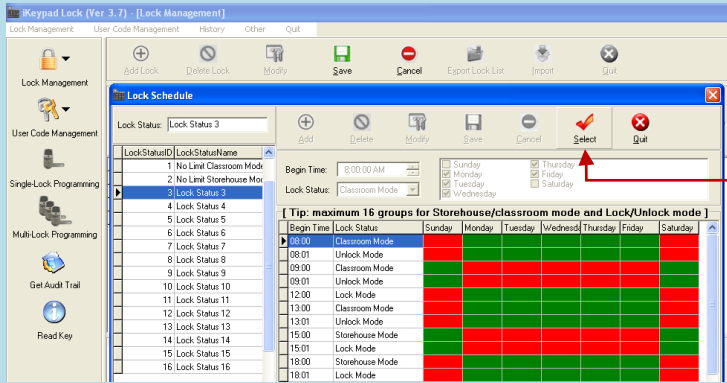

After selecting the status group you want, click on the 'Select' icon

Remember: You must complete Single lock, Multi-lock, or Copy Lock programming steps to then write the new schedule databases into the lock(s) by using the USB blue dot receptor and the DS1977 programming key to create the key to program the lock(s) themselves.

Activation / Expiration Date Setting

Overview:

This function is used to set the activation date and expiration date of valid keys. The first group is a default setting where no time limit is applied to the user. The rest of groups can be set to an activation date and expiration date by the operator of the software. Only one group can be applied to a particular user on a particular lock. However, different locks can have different groups applied to that same user. (In other words, you can control the access of a user to a particular door without restricting that same user from access to a different door)

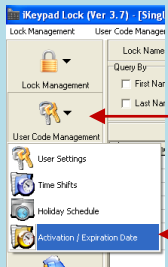

Click on the 'User Code Management' icon, then select and click on 'Activation / Expiration Date'

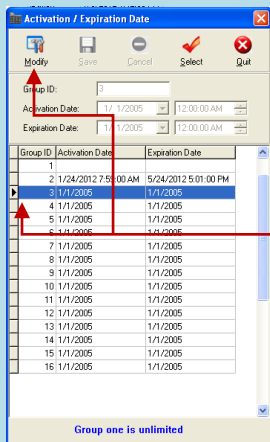

Click on a group ID to modify for your use, or Group ID #1 to remove an existing group from a user, then click on the 'Modify' icon

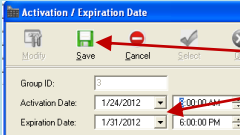

Use the pull-down menu arrows of set the desired 'Activation / Expiration' dates and times, *then* click on the 'Save' icon



Select 'Single-Lock Management.'

Select the lock you wish to apply changes to from the drop-down menu

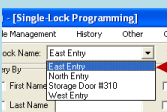

Click on the Activation / Expiration data entry location for the user you wish to apply it to, then click on the group schedule you want for the user in the popup window. Click on the 'Select' icon at the top of the popup window.

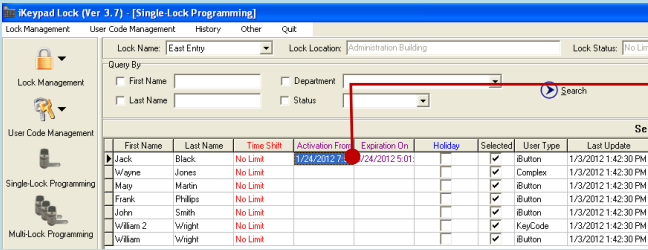
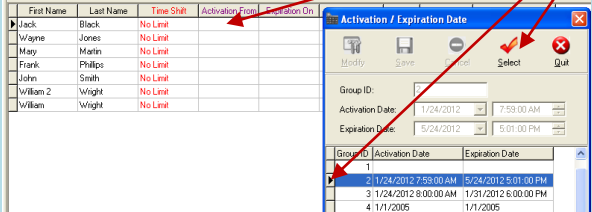

The Activation / Expiration group information will appear in the users data. Complete any other changes you wish and issue the DS1977 program key in the normal way to program the lock.

Remember: You must complete Single lock, Multi-lock, or Copy Lock programming steps to then write the new schedule databases into the lock(s) by using the USB blue dot receptor and the DS1977 programming key to create the key to program the lock(s) themselves.

'Holiday' / 'Exception Date' Setting

Overview:

This function is used to set or restrict access during periods such as holidays, facility shutdowns, and vacation periods. The first group set as No Limit default setting. The holidays can be set as a single day or multiple days. The selected user iButton keys or codes will be restricted from access for all of the exception dates entered in this list.

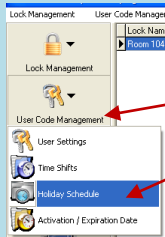

Select 'User Code Management' from the left side of the menu, then click on 'Holiday Schedule' from the drop-down menu

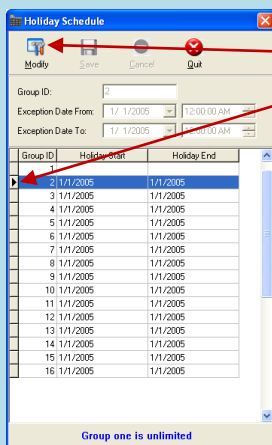

Select a group from 2-16 to add or change, then click on 'Modify' at the top of the menu

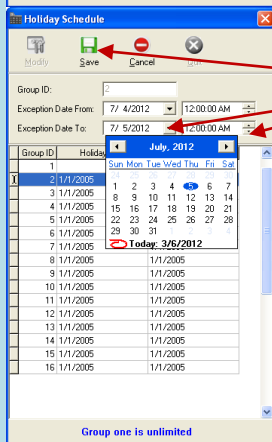

Use the drop-down arrows to enter or change the date and times for the holiday or exception dates you want. Click on 'Save' when completed with modifying the group.

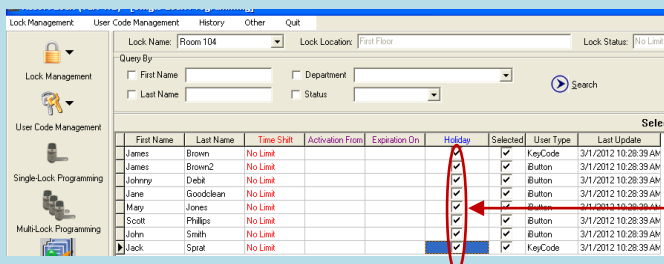

To assign the holiday schedule to particular users, use 'Single Lock' or 'Multilock' programming, click on the 'Holiday' check box for the users you want to follow the holiday schedules

Remember: You must complete Single lock, Multi-lock, or Copy Lock programming steps to then write the new schedule databases into the lock(s) by using the USB blue dot receptor and the DS1977 programming key to create the key to program the lock(s) themselves.

IV. Lock Management

General Overview:

The lock management utilities help you manage both the locks themselves and the records the locks keep. It primarily allows you to create and issue DS1977 program keys that can, among other things, set lock details such as time and date, lock-back delay for storehouse mode, special temporary user keys and keypad codes, and get information FROM locks to compare to the data in this program's database.



Click 'Lock Management' on the main screen and select 'Lock Maintenance' from the drop down menu

Set Parameter Key

Overview:

This process can set many lock parameters, such as LED 'Blink', 'Lock Back Delay Time', Set 'PC Time' (adjust lock time to a user set *future* time), and enable "Daylight Saving" time modes. To set the lock parameters:

- Select the function you want to change, snap the DS1977 program key into the USB blue dot receptor , then press the "Issue Key" button.
- Take the DS1977 program key to the lock and touch it to the lock reader until it beeps twice to set the parameters into the lock. (Use 'Set Time' key menu for 'normal' lock time setting)
- The 'PC Time' function is sometimes used to set the time of a lock when a DS1904/1994 time set key is *not* available. It allows the user to program a locks' clock to a *future* time or date using only the regular DS1977 program key. In doing so, it is possible to allow for the natural delays in physically taking the program key to the lock you desire to set the time on. If the lock is close by the PC, you can just click on the check box and the PC's clock current time and date will be used.

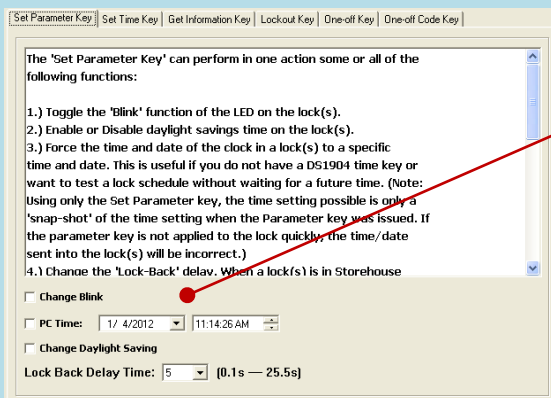

Select and modify the function you want to change, snap the DS1977 program key into the USB blue dot receptor, then click the "Issue Key" button. Take the DS1977 program key and apply it to the lock reader until you get 2 beeps, showing that the lock has recorded the changes you made.

Set Time Key

Overview:

This process uses a DS1977 program key *and* a DS1904 (or DS1994) iButton key to set the real time and date of the lock.

- Follow the on screen instructions to first 'Issue' the DS1977 key to 'allow' the lock to accept a time setting, then 'Issue' the DS1904 (or 1994) time set key.
- Apply first the DS1977 program key to each lock, then apply the DS1904 (or 1994 time) time set key to each lock. The DS1904/1994 key has a real-time clock inside that continues to run, so that even if there is delay at getting to a lock the time will still be right when applied to the lock.

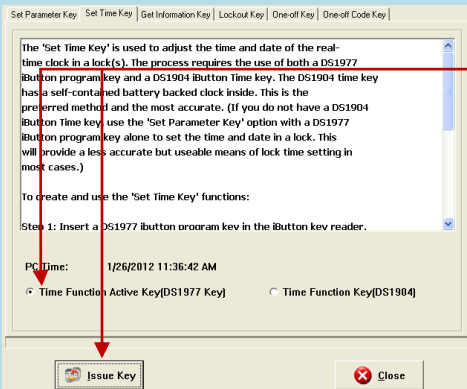

Snap in the DS1977 program key into the USB blue dot receptor, select 'Time Function Active Key', then 'Issue key'. Remove the DS1977 key from the USB blue dot receptor

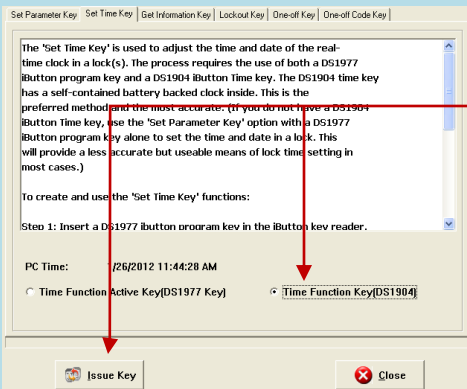

Snap in the DS1904 (or DS1994) time set key into the USB blue dot receptor, select 'Time Function Key', then 'Issue key'. Remove the time set key from the USB blue dot receptor

Tip: Other than DS1904/1994 real time key, just the DS1977 program key can also set the time of the lock. This is just a 'snap-shot' of the time however. Using just the program key set will cause some time errors since programming the key and programming the lock will take some time, particularly if there is a long distance between the computer and the lock. We recommend using the DS 1904/1994 real time key if the delay in applying the key to the lock is excessive.

Get Information Key

Get Information Key is a useful tool to retrieve the existing information from a lock, such as: user key list, lock time, lock mode, lock / user group schedules, lock ID, or battery voltage.

- To get the lock information, snap the DS1977 program key into the USB blue dot receptor, click the “Issue Key” button, and then press the program key to the lock itself. The lock will make a series of chirping sounds, and when it is finished it will beep twice.
- Remove the program key and snap it into the USB blue dot receptor.
- Press the “Read Key” button to read the information. Using the tabs along the top of the information screen, you can compare the information inside the lock to the information in the PC program.

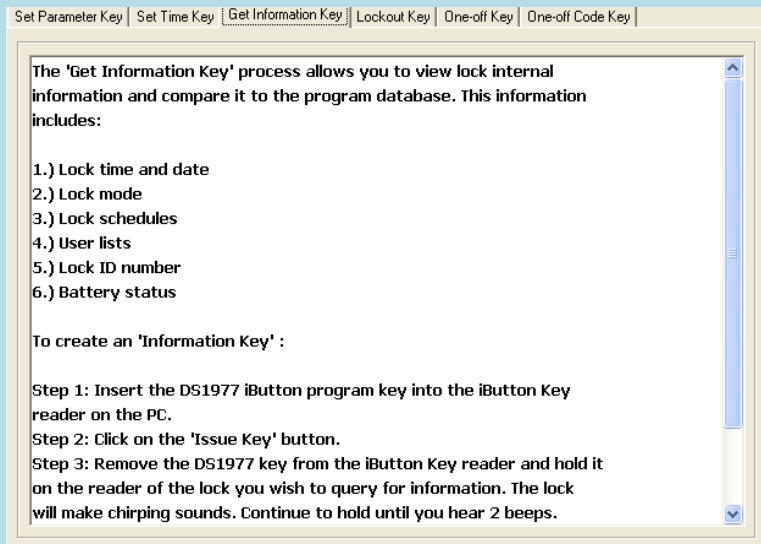

Key Serial ID: 1B000000803A637		Key Type: Get Information Key			
Time Shift Setting	Lock Status Setting	Activation/Expiration Date Setting	Holiday Setting	Key List	Lock Information
Lock Serial ID:	6A5D0E010B4FBE01	Lock Name:	East Entry	Blink:	Enable
Time In Lock:	1/4/2012 11:23:03 AM	Lock Location:	Administration Building	Battery Voltage:	4.3
Key List Status:	Enable	Manual Setup Status:	Disable	User Number:	33
DayLight Saving Status:	Enable	Lock Mode:	Classroom Mode	Audit Trial Number:	170
DayLight Saving:	No	Lock Hardware Version:	2121		
Lock Level:	High	Lock Software Version:	8.6		

You can see and compare the lock internal programming to that of the PC program database. Additionally you can see the firmware revision number of the lock as well as the lock battery condition. Under 4.9 indicates the batteries should be replaced soon.

Lockout Key

Overview:

Lockout forbids all assigned keys/codes from operating the lock. Apply any Lockout key to put the lock in Lockout Mode, and apply again to release the Lockout Mode. To apply the key, snap the program key into the USB blue dot receptor, select open door or close door, press the "Issue Key" button, and then press the program key to the lock to set the Lockout Mode. There are two types of Lockout Modes.

The 'Lockout Key' allows a DS1977 iButton program key to be used to block all other users from changing a lock status from a locked or unlocked state. It can be thought of as a master over-ride user key. It can be selected to function for one or all locks in the database.

To create a 'Lockout Key':

Step 1: Check the 'Selected' block next to any locks you wish the 'Lockout Key' to control.

Step 2: Select if you want the key programmed to keep the door(s) locked or unlocked.

Open Door Close Door

Serial ID	Lock Name	Lock Location	Selected
8C1104020B4FBE01	West Entry	Administration Building	<input checked="" type="checkbox"/>
EF2704020B4FBE01	South Entry	Classroom Building	<input type="checkbox"/>
6A5D0E010B4FBE01	East Entry	Administration Building	<input type="checkbox"/>
EC790F010B4FBE01	North Entry	Classroom Building	<input type="checkbox"/>
FDFD00020B4FBE01	Storage Door #310	Facilities Building	<input type="checkbox"/>

Lockout and Open: Lock will stay unlocked and disable all other users.

Lockout and Close: Lock will stay locked and disable all other users.

Multiple locks can be selected in one key. Select the locks you wish to use the DS1977 program key to operate as a Lockout key, then 'Issue Key'.

One-Off key/One-Off Code

Overview:

These are two types of One Time User: one time service key using the DS-1977 programming key or keypad codes (up to 10)

➤ One-Off Key

Step1: Select locks from Lock List.

Step2: Issue key.

This key will immediately work on the selected lock one time only. (No need set up on the lock)

The screenshot shows a software window titled 'One-off Key' with a menu bar containing 'Set Parameter Key', 'Set Time Key', 'Get Information Key', 'Lockout Key', 'One-off Key', and 'One-off Code Key'. The main area contains the following text:

The 'One Off Key' allows a DS1977 iButton program key to be used as a one-time user key. It can be selected to function as a single-use user key for one or all locks in the database.

To create a 'One-Off Key':

Step 1: Check the 'Selected' block next to any locks you wish the

Serial ID	Lock Name	Lock Location	Selected
8C1104020B4FBE01	West Entry	Administration Building	<input type="checkbox"/>
EF2704020B4FBE01	South Entry	Classroom Building	<input type="checkbox"/>
6A5D0E010B4FBE01	East Entry	Administration Building	<input checked="" type="checkbox"/>
EC790F010B4FBE01	North Entry	Classroom Building	<input type="checkbox"/>
FDFD00020B4FBE01	Storage Door #310	Facilities Building	<input type="checkbox"/>

Below the table is an 'Issue Key' button. A text box on the right contains the instruction: 'Select the locks you wish to use the DS1977 program key to operate as a one-time lock key, then 'Issue Key''. Red arrows point from this text box to the 'Selected' column of the table and to the 'Issue Key' button.

➤ **One-Off Code**

Enter up to 10 'One-Off ' codes in the list, then use the DS1977 programming key to issue programming and assign the codes to each lock. To set the codes, snap the program key into the USB blue dot receptor, press the 'Issue Key' button, and then press the program key to the lock reader until the lock beeps twice to set the codes. You may then use the keypad code(s) to open a lock(s) a single time.

The 'One-Off Code Key' allows the adding of up to ten one-time use keypad codes. Once a user uses a one-time code on a lock, the key becomes invalid. This is typically used to allow vendors or maintenance workers a single access. Once issued, this key can be used on a single lock or any group of locks already in the PC database.

To create a 'One-Off Code Key':

Code NO	One-off Code
1	
2	
3	
4	
5	
6	
7	
8	
9	
10	

Save

Clear

Issue Key

Enter the 'One-Off' one-time keypad codes you wish, then click on 'Save'. Click on the 'Issue Key' to apply the changes to the DS1977 program key. Press the program key to each lock you want to have these 'One-Off' keypad codes.

V. Audit Trial

Overview:

This function allows you to download the user records from locks on the PC program for your records or to export to Microsoft 'Excel' files

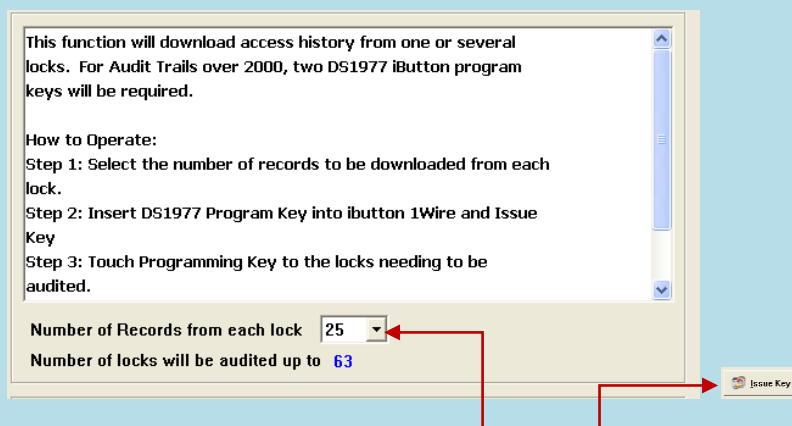
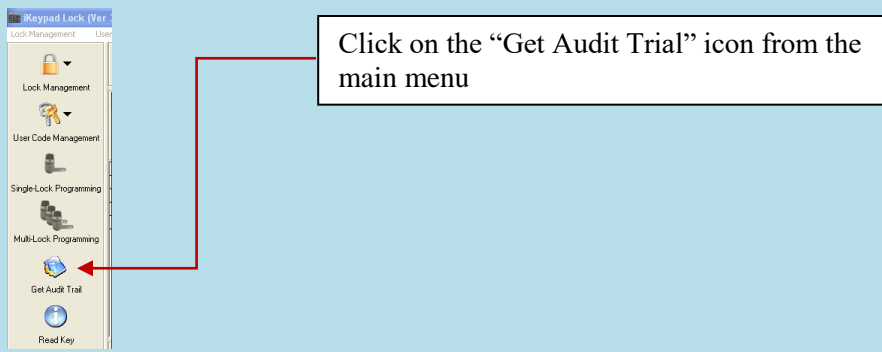

- Select the number of records you want from each lock from the drop-down menu. As many as 3200 records can be downloaded from a single lock if 2 DS1977 program keys can be used. If only a single DS1977 program key is available, the maximum number is 2000 records. The more records that are requested, the fewer number of locks that can be downloaded at one time.
- Snap the program key to the USB blue dot receptor and click on "Issue Key" button.
- A 'Write Get Audit Trail key OK' message will pop up. Click OK to close the screen.
- Unsnap the DS1977 program key from the PC reader and touch the lock(s) iButton reader. You will hear a long series of chirps – do NOT stop touching the lock reader until you hear a final two beeps. This indicates the download was complete. For very long audit trails, this may take some time. Be patient.
- Snap the program key back to the USB blue dot receptor and click "Read key" button. The read key screen will pop up; the audit trail records will scroll onto the screen. Again, be patient for long audit trails to finish uploading.
- Click 'Save to Audit trail History' button, and the audit trail records will be saved in the 'Audit History' database. Do not save an audit trail to history more than once, as the history database accumulates all saved entries and may produce duplicate records.

Key Serial ID: 1B000000803A637

Key Type: Multi-Lock Audit Trail Key

Number of records from each lock: 25

Number of locks has been audited: 1

 Save to Audit Trail History

Entry	First Name	Last Name	Lock Action	Lock Time	Lock Name	Lock Location	SerialID	Code
1	Admin	Admin	Download Lock Audit Trial	1/16/2012 4:41:07 PM	East Entry	Administration Building	1B0000000803A637	
2	Frank	Phillips	Invalid Access(Time Shift Setting)	1/13/2012 5:00:37 PM	East Entry	Administration Building	AD000000DE8C0201	
3	Jack	Black	Invalid Access(Time Shift Setting)	1/13/2012 5:00:29 PM	East Entry	Administration Building	FA00000F3048B001	
4	Jack	Black	Close Lock With Key	1/13/2012 4:59:39 PM	East Entry	Administration Building	FA00000F3048B001	
5	Jack	Black	Open Lock With Key(Classroom Mode)	1/13/2012 4:58:45 PM	East Entry	Administration Building	FA00000F3048B001	
6	Frank	Phillips	Close Lock With Key	1/13/2012 4:48:44 PM	East Entry	Administration Building	AD000000DE8C0201	
7	Frank	Phillips	Open Lock With Key(Classroom Mode)	1/13/2012 4:34:33 PM	East Entry	Administration Building	AD000000DE8C0201	
8	Admin	Admin	Single-Lock Programming	1/13/2012 4:33:40 PM	East Entry	Administration Building	1B000000803A637	
9	Frank	Phillips	Close Lock With Key	1/13/2012 4:08:48 PM	East Entry	Administration Building	AD000000DE8C0201	
10	Frank	Phillips	Open Lock With Key(Classroom Mode)	1/13/2012 4:05:06 PM	East Entry	Administration Building	AD000000DE8C0201	
11	Frank	Phillips	Close Lock With Key	1/13/2012 4:05:06 PM	East Entry	Administration Building	AD000000DE8C0201	
12	Admin	Admin	Single-Lock Programming	1/13/2012 4:05:02 PM	East Entry	Administration Building	1B000000803A637	
13	Admin	Admin	Download Lock Audit Trial	1/13/2012 2:29:04 PM	East Entry	Administration Building	1B000000803A637	
14			Lock Auto Opened	1/13/2012 1:01:00 PM	East Entry	Administration Building	0100000000000000	
15			Lock Auto Closed	1/13/2012 12:00:00 PM	East Entry	Administration Building	0200000000000000	
16			Lock Auto Opened	1/13/2012 8:01:00 AM	East Entry	Administration Building	0100000000000000	
17			Lock Auto Closed	1/12/2012 6:01:00 PM	East Entry	Administration Building	0200000000000000	
18			Lock Auto Opened	1/12/2012 1:01:00 PM	East Entry	Administration Building	0100000000000000	
19			Lock Auto Closed	1/12/2012 12:00:00 PM	East Entry	Administration Building	0200000000000000	
20			Lock Auto Opened	1/12/2012 8:01:00 AM	East Entry	Administration Building	0100000000000000	
21			Lock Auto Closed	1/11/2012 6:01:00 PM	East Entry	Administration Building	0200000000000000	
22			Lock Auto Opened	1/11/2012 1:01:00 PM	East Entry	Administration Building	0100000000000000	
23			Lock Auto Closed	1/11/2012 12:00:00 PM	East Entry	Administration Building	0200000000000000	
24			Lock Auto Opened	1/11/2012 8:01:00 AM	East Entry	Administration Building	0100000000000000	
25			Lock Auto Closed	1/10/2012 6:01:00 PM	East Entry	Administration Building	0200000000000000	

 Read Key

 Export Data

 Close

(If you wish to keep a permanent record of the audit trail, click on 'Save To Audit History' after reading the key)

Snap the DS1977 program key back in the reader then click 'Read Key'

You may also export the audit trail to a Microsoft Excel spreadsheet by clicking on 'Export Data'. You must have Excel installed in your computer for this function to operate.

VI. History

Lock Audit History

Overview:

The Audit Trail History is a way of keeping a complete record of lock activities from the Audit Trail function.

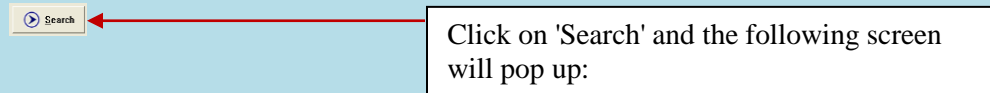
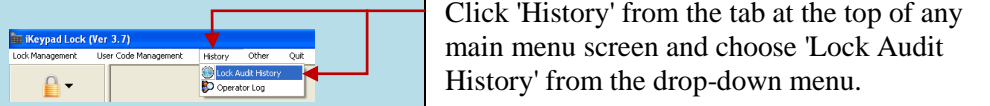

Entry	First Name	Last Name	Open Lock Type	Open Lock Time	Status	Lock Name	Lock Location	SerialID
1	Jack	Black	Open Lock With Key(Classroom Mode)	1/4/2012 12:01:57 PM	Active	South Entry	Classroom Building	FA00000F3048B001
2	Mary	Martin	Close Lock With Key	1/4/2012 12:01:54 PM	Active	South Entry	Classroom Building	5E000000451E0401
3	Frank	Phillips	Open Lock With Key(Classroom Mode)	1/4/2012 12:01:51 PM	Active	South Entry	Classroom Building	AD000000DE8C0201
4	Jack	Black	Open Lock With Key(Classroom Mode)	1/4/2012 12:01:38 PM	Active	North Entry	Classroom Building	FA00000F3048B001
5	John	Smith	Close Lock With Key	1/4/2012 12:01:37 PM	Active	North Entry	Classroom Building	4B0022336F26F001
6	Frank	Phillips	Open Lock With Key(Classroom Mode)	1/4/2012 12:01:35 PM	Active	North Entry	Classroom Building	AD000000DE8C0201
7	Jack	Black	Close Lock With Key	1/4/2012 12:01:26 PM	Active	East Entry	Administration Building	FA00000F3048B001
8	Mary	Martin	Open Lock With Key(Classroom Mode)	1/4/2012 12:01:25 PM	Active	East Entry	Administration Building	5E000000451E0401
9	Frank	Phillips	Close Lock With Key	1/4/2012 12:01:23 PM	Active	East Entry	Administration Building	AD000000DE8C0201
10	John	Smith	Open Lock With Key(Classroom Mode)	1/4/2012 12:01:21 PM	Active	East Entry	Administration Building	4B0022336F26F001
11			Lock Auto Closed	1/4/2012 12:00:00 PM		South Entry	Classroom Building	0200000000000000
12			Lock Auto Closed	1/4/2012 12:00:00 PM		North Entry	Classroom Building	0200000000000000
13			Lock Auto Closed	1/4/2012 12:00:00 PM		West Entry	Administration Building	0200000000000000
14			Lock Auto Closed	1/4/2012 12:00:00 PM		East Entry	Administration Building	0200000000000000
15	Admin	Admin	Download Lock Audit Trial	1/4/2012 11:59:08 AM	Permitted	West Entry	Administration Building	1B0000000803A637
16	Frank	Phillips	Close Lock With Key	1/4/2012 11:59:01 AM	Active	West Entry	Administration Building	AD000000DE8C0201
17	Jack	Black	Open Lock With Key(Classroom Mode)	1/4/2012 11:58:56 AM	Active	West Entry	Administration Building	FA00000F3048B001
18	John	Smith	Close Lock With Key	1/4/2012 11:58:50 AM	Active	West Entry	Administration Building	4B0022336F26F001
19	Frank	Phillips	Open Lock With Key(Classroom Mode)	1/4/2012 11:58:48 AM	Active	West Entry	Administration Building	AD000000DE8C0201
20	Mary	Martin	Close Lock With Key	1/4/2012 11:58:45 AM	Active	West Entry	Administration Building	5E000000451E0401
21	Admin	Admin	Download Lock Audit Trial	1/4/2012 11:58:02 AM	Permitted	West Entry	Administration Building	1B0000000803A637
22	Admin	Admin	Download Lock Audit Trial	1/4/2012 11:56:10 AM	Permitted	East Entry	Administration Building	1B0000000803A637
23	Admin	Admin	Download Lock Information	1/4/2012 11:23:12 AM	Permitted	East Entry	Administration Building	1B0000000803A637

Query By

Open Lock Time: 1/ 4/2012 To 1/ 4/2012 Lock Name: First Name:

Open Lock Type: Lock Location: Last Name:

Order By

Open Lock Type Lock Name Lock Location Last Name Open Lock Time

You may also export the audit trail history to a Microsoft Excel spreadsheet by clicking on 'Export'. You must have Excel installed in your computer for this function to operate.

Here's how to change your view of the saved data:

- Click on which 'Query By' type you desire, use the pull-down arrows and select the key words / date you want.
- In 'Order By' check the records order you desire. The default is open lock time.
- Click the 'Search' button, the records will appear on screen.
- Click 'Clear' to clear the entire contents of the PC audit history database only.

Note: Using the 'Clear' function only clears the PC database Audit History records, not lock memory of audit trails. There is NO facility in this software to clear audit trail information from locks themselves except by completely re-initializing a lock with the reset button and performing a new lock setup. Locks themselves can generally hold about 3200 entries in memory per lock, after which the oldest entries are automatically deleted inside the lock to make room for new entries. This is handled internally to the lock itself and not by the PC software.

Operator Log

Overview:

This function allows usage tracking of the operator of the PC software

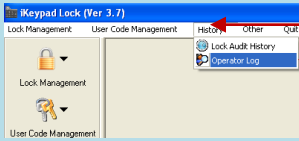

Select 'History' from the tabs along the top, then click on 'Operator Log' from the drop down menu

Login Time	Logout Time	Login Name	Login Level
1/2/2012 2:40:12 PM	1/2/2012 2:48:51 PM	dallas	Administrator
1/2/2012 2:51:02 PM	1/3/2012 10:15:50 AM	dallas	Administrator
1/3/2012 10:25:32 AM	1/3/2012 10:26:43 AM	dallas	Administrator
1/3/2012 10:43:43 AM	1/3/2012 12:28:20 PM	dallas	Administrator
1/3/2012 12:28:48 PM	1/3/2012 1:32:07 PM	dallas	Administrator
1/3/2012 1:34:50 PM	1/3/2012 2:32:13 PM	dallas	Administrator
1/4/2012 10:09:03 AM	1/4/2012 1:26:44 PM	dallas	Administrator
1/5/2012 3:00:15 PM		dallas	Administrator

Click on 'Search', with whatever (if any) 'Query By' or 'Order By' filters you may wish to use. The requested listings of operator use will be listed.

]

Section 3 Non-software Guide

This section is for the use of either the Eternity 4 or Eternity 5 without using PC software. If you use the software to setup the lock, then you can no longer use the keypad to program the E4/E5 without resetting the lock. Likewise, if you use the keypad and master code to manually setup the lock, you cannot use the software with the lock unless you reset and do a new lock setup from scratch.

Note: All E4 and E5 models can be programmed manually using the keypad. All E4 models can be programmed using PC software or manually with the keypad, however only certain E5 models can be programmed by either method. Specific model information can be found in the software portion of the manual.

I. General Information:

- **Exit Setting:** Enter * to exit the setting procedure, or wait for 10 seconds
- **Low Battery warning:** When the voltage drops below 4.8V, after entering a valid code, the red LED will flash and beep five times.
- **Unlock:** Green light flashing twice and Beeps twice.
- **Lock:** Red Light flashing twice, and beeps twice.
- **Reset:** To set the lock back to factory default settings, press and hold the reset button for about 10 seconds. When the LED starts flashing, release the reset button and press the '#' key while the LED is still flashing. The lock will beep 3 times, indicating the reset was successful. (The reset button is located below the battery holder.) This procedure applies to lock firmware v8.6. **Other firmware versions may require a slightly different procedure.** Contact Technical assistance at 972-820-6450 if required.

The reset button for the Eternity 4 is shown below.

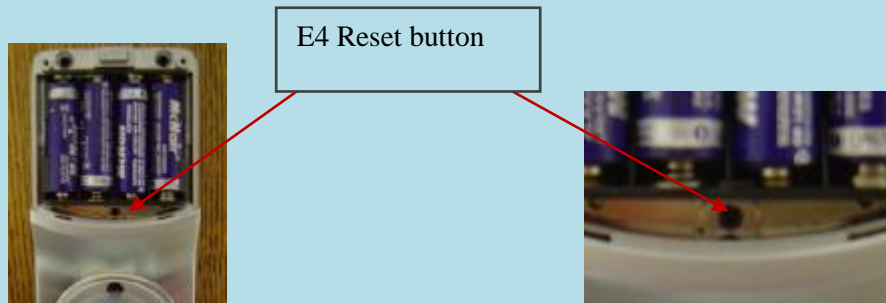

The reset button for the Eternity 5 is shown below.

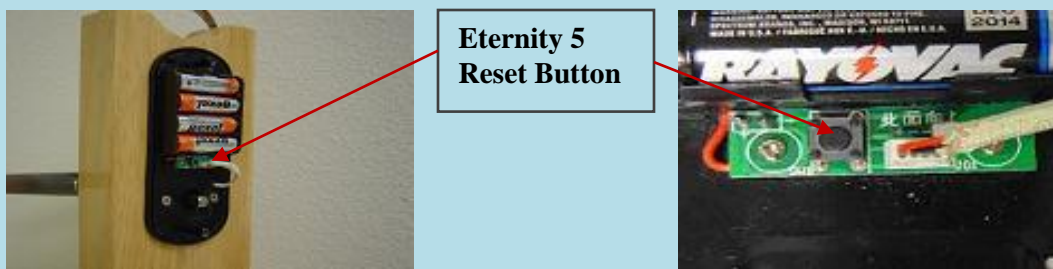

II. Manufacture Default Setting:

- **Daylight Saving:** Disabled
- **Auto unlock/lock:** Disabled
- **Default Programming Code:** 123456
- **Lock Mode:** Storehouse

III. Steps to setup a new lock *(Steps 1-4 must be completed in that order)*

1. Reset the lock to factory defaults. Press and hold the reset button for about 10 seconds. When the LED starts flashing, release the reset button and press the '#' key while the LED is still flashing. The lock will beep 3 times, indicating the reset was successful. Lock firmware versions other than v8.6 may require a slightly different procedure for reset.
2. Change the master code (For example, change to **223344**)
123456 # 11 # 223344 # 223344
3. Enable daylight saving (optional)
223344 # 31
4. Set lock time (For example, set time as January 23, 2008, 2:45PM)
223344 # 88 # 1201231445# (2 digit year, 2 digit month, 2 digit day, then time in 24 clock format)
5. Add user code (For example, add user keypad code 1357 to the lock)
223344 # 01 # 1357 # #
6. Add iButton key (Optional)
223344 # 01 # iButton key touch lock reader #
7. Set any schedules for user codes, iButton keys, or automatic lock functions (Optional)

IV. Types to operate the lock:

- **Keycode:** User Code, #
- **iButton:** iButton key touch lock reader
- **iButton+Keypad:** iButton touch lock reader, LED lights green, enter user code, #
- **One time service code:** One time code, #
- **Manual key:** Turn the override key 90 degree clockwise, then turn the handle

V. Terms:

Master code: The master code puts the lock into a programming mode. ***It will not lock/unlock the lock.*** When #, **master code**, # is entered, the red LED indicates the lock is in a programming mode. If more than 6 seconds pass in between programming entries, the lock will return to normal operational state. For maximum security **it is necessary to change the default master code of 123456.**

Installer code: Installer code is a default temporary code (**0**) for installer testing the lock. The code will be deleted after the first new user code is added to the lock.

User code: User code is the Normal code for the day-to-day operations.

Service code: Service Codes are used for a special purpose such as maintenance personnel or vendors. Service Code only grants one time access. Total of 10 sets of service codes can be programmed to each lock.

Index #*: Each code or iButton will be associated with a unique number, called the index# (or slot#). The Index # is auto generated by lock and starts with 000. The highest Index# will be 299; therefore up to 300 users can be added to each lock.

**** Please log the user code along with its index # for future reference. It is required to delete particular users later should you need to.***

Passage mode: When Passage Mode is enabled, the lock will stay in unlocked after first valid entry. Re-enter a valid entry to lock back.

Storehouse mode: for each valid entry, lock will automatically lock back in 5 seconds.

Lockout: Enable the Lockout mode will freeze the lock at its current state (Lock or unlock), temporarily disable all the user codes and iButton keys. Re-enter the function code 99 to disable the lockout mode, and resume

Reset:

All settings will be restored to factory default settings.

VI. Functions

How to change programming code (and not delete existing user codes)

❑ **Function Code: 11#**

- {#}+{default master code#}+{11#}+{new master code#}+{new master code#}

How to change programming code (and delete all existing user codes)

- ❑ **Function code: 22#**
 - {#}+{current master code#}+{22#}+{new master code#}+{new master code#}

How to enable daytime saving

- ❑ **Function Code: 31#**
 - {#Master code#}+{31#}

How to set date and time

- ❑ **Function Code: 88#**
 - {#Master code#}+{88#}+{yymmddhhmm#}

How to add one user code (no time restriction)

- ❑ **Function Code: 01#**
 - {#Master code#}+{01#}+{user code# # #}

How to add multi-user code (no time restriction)

- ❑ **Function Code: 01#**
 - {#Master code#}+{01#}+{user code(1)# # #}+{user code(2)# # #}+{user code3###} ... and so on

How to add one user access code (with time restriction)

- ❑ **Function Code: 01#**
 - {#Master code#}+{01#}+{user code#}+{yymmddhhmm#(start time)}+{yymmddhhmm#(ending time)}

How to add multi-user code (with time restriction)

- ❑ **Function Code: 01#**
 - {#Master code#}+{01#}+{user code#(1)}+{yymmddhhmm#(start)}+{yymmddhhmm#(ending time)} + {user code#(2)}+{yymmddhhmm#(start)}+{yymmddhhmm#(ending)} ...and so on

How to add one iButton key (no time restriction)

- ❑ **Function Code: 01#**
 - {#Master code#}+{01#}+{touch iButton # #}

How to add multi-user iButton key (no time restriction)

- ❑ **Function Code: 01#**
 - {#Master code#}+{01#}+{iButton(1)# #}+{iButton(2)# #} ...and so on

How to add user code + iButton key as dual user (no time restriction)

- ❑ **Function Code: 01#**
 - {#Master code#}+{01#}+{user code#}+{touch iButton# #}
(To access door: touch “iButton key” + “user code #”)

How to add one iButton key (with time restriction)

- ❑ **Function Code: 01#**
 - {#Master code#}+{01#}+touch {iButton}+{yymmddhhmm#(start time)}+{yymmddhhmm#(ending time)}

How to add multi-iButton key (with time restriction)

- ❑ **Function Code: 01#**
 - {#Master code#}+{01#}+touch {iButton key(1)}+{yymmddhhmm#(start)}+{yymmddhhmm#(end time)}+ touch {iButton key(2)}+{yymmddhhmm#(start)}+{yymmddhhmm#(end time)} ...and so on

How to disable one user code or iButton key with index#

- ❑ **Function Code: 02#**
 - {#Master code#}+{02#}+{index #}

How to enable one user code or iButton key with index#

- ❑ **Function Code: 03#**
 - {#Master code#}+{03#}+{index code#}

How to enable passage mode and schedule (lock back when the passage mode end)

- ❑ **Function Code: 15#**
 - **{#Program#}+{15#}+{Schedule}+{#}+{begin time & ending time#}**

How to disable passage mode

- ❑ **Function Code: 16#**
 - **{#Master#}+{16#}**

How to enable LED blink light (on & off)

- ❑ **Function Code: 18#**
 - **{#Master code#}+{18#}**

How to disable daytime saving

- ❑ **Function Code: 32#**
 - **{#Master code#}+{32#}**

How to set up one time service code (up to 10 service codes)

- ❑ **Function Code: 33#**
 - **{#Master code#}+{33#}+{service code(1)#}+ {service code(2)#}+... and so on**

How to delete user code or iButton key with index

- ❑ **Function Code: 44#**
 - **{#Master code#}+{44#}+{index#}**

How to delete one user code / iButton key (without index number)

- ❑ **Function Code: 46#**
 - **{#Master code#}+{46#}+{user code#} (or iButton key w/o trailing # key)**
 - **NOT available on non-software locks with v4.1 firmware**

How to de-active user code / iButton key (without index number)

- ❑ **Function Code: 48#**
 - **{#Master code#}+{48#}+{user code} (or iButton key)**

How to In-active user code or iButton key without index number

- ❑ **Function Code: 47#**
 - **{#Master code}+{47#}+{user code} (or iButton key)**

How to enable auto-unlock function

- ❑ **Function Code: 64#**
 - **{#Master code#}+{64#}**

How to setup auto-unlock time (it will auto unlock the door every day at assigned time)

- ❑ **Function Code: 63#**
 - **{#Master code#}+{63#}+{HHMM#}**

How to disable auto-unlock function

- ❑ **Function Code: 65#**
 - **{#Master code#}+{65#}**

How to enable auto-lock function

- ❑ **Function Code: 67#**
 - **{#Master code#}+{67#}**

How to setup auto-lock time (it will auto lock the door every day at assigned time)

- ❑ **Function Code: 66#**
 - **{#Master code#}+{66#}+{HHMM#}**

How to disable auto-lock function

- ❑ **Function Code: 68#**
 - **{#Master code#}+{68#}**

How to enable / disable Lock-out (lock out all users if enabled)

- ❑ **Function Code: 99#**
 - {#Master#}+{99#}

How to program schedule week & time

- ❑ **Function Code: (45#)**
 - 1st enable daylight saving
 - 2nd set up date & time (use 88# function code)
 - 3rd adding user code or iButton key in advance (see above how to add user code & iButton)
 - 4th program schedule (as below)

Weekly Chart

Sun	Mon	Tue	Wed	Thu	Fri	Sat
7	1	2	3	4	5	6

Formula: {#master code#}+{function code#}+{user code# or iButton}+{select week number#}+{begin time & ending time#}

• How to program schedule with an “user code”

Example: {#23456# + 45# + 2222# + 135# + 08301730#}

#23456#	45#	2222#	135#	0830	1730#
Master Code	Function code	User code	Mon/Wed/Fri	Beginning time	Ending Time

0800=8:00AM 1730=5:30PM

Section 4 Trouble Shooting Guide

Problem	Possible Reason	Solution
iButton Key is not working	Time restricted key or invalid user	1. Check Time Shift setting 2. Use “Get Lock Information Key” to see if this key is in the list, and if the internal clock is correct
Red light is on and three beeps	Batteries low	1. Change Batteries 2. Reset the lock time and date
Green light is on and two beeps, but motor is not running	No power to lock motor	Make sure the motor wire is firmly connected to the PCB
Temporary Key Code is not working	Access code is expired or lock time is incorrect	Check the expiration date on the access code and time / date inside lock
Lock doesn't accept any valid iButton key	Lock is in Lockout Mode	Issue a new Lockout Key to release the lockout mode
Will changing battery erase the key list	NO	The key list and timetable are stored inside the flash memory, disconnecting the batteries can't erase the non-volatile, solid-state flash memory.
After changing the battery. Temporary codes stop working	Internal Time is lost	Do a Time Key or Parameter key to adjust internal lock time.

If you need additional support, please contact your local distributor or at 1-972-820-6450

Warranty Registration Form

Customer Information:

Date Purchased: _____ Purchase From (company name): _____

Model: _____ Serial Number: _____

First Name: _____ Last Name: _____

Daytime Phone: _____ E-mail: _____

Shipping Address: _____

City: _____ State: _____ Zip Code: _____

✂-----✂-----✂-----

Mail Registration Form to:

Uaccess LLC

Attn: Registration Dept

1904 University Business Drive, Ste. 304

McKinney, TX 75071

Warranty and RMA Guidelines

Receiving Your Order

1. Upon receipt of your new merchandise, please inspect carefully as to the contents and condition. All claims for damaged or missing items MUST be reported to Uaccess LLC within five (5) business days upon receipt of merchandise. In the event your package arrives damaged, it is the responsibility of the customer to contact the carrier to inspect the package to assure full refund/replacement. All packaging MUST be retained until the problem has been resolved.
2. Carefully unpack and inspect all merchandise. Please DO NOT damage the manufacturer's packaging. DO NOT throw away any material included with the package until you are absolutely certain the product has not been damaged. We cannot accept merchandise for return incomplete or damaged, or missing packing material.
3. Retain your Invoice. Read all instruction manuals BEFORE testing your equipment.
4. Uaccess accepts neither responsibility nor liability for any consequential or incidental damages resulting from the installation or operation of any merchandise purchased from us.

Return/Exchange Policy

NO RETURNS WILL BE ACCEPTED WITHOUT R.M.A# (Return Merchandise Authorization Number)

You can return or exchange, excluding any shipping and handling charge, within a period of thirty (30) days for lock merchandise and fourteen (14) days for accessories, if you are not satisfied with the products. If defective, items may be exchanged for the same model only. Special Order items are not returnable. We will not accept any returns or exchanges on Batteries, Memory Chips, User Keys or any other consumable products.

Uaccess LLC basically does not take or make ADVANCE SHIP or CROSS SHIP arrangements unless otherwise preapproved by authorization within 1 year of purchase.

Prior to returning any item, YOU MUST call Customer Service for pre-approval RMA number. All merchandise purchased from Uaccess LLC is sold in its original factory packaging with all contents as supplied by us. Items can be returned only if in original packaging, same new condition as sold with literature/instructions. Place the manufacturer's box into a shipping box. Please do not put any stickers or labels on the original manufacturer's packaging. Please ship the items back to us with freight prepaid. We are not responsible for lost or damaged packages returning to us.

Attach a copy of original invoice with freight pre-paid for Warranty / RMA service.

If any of the above conditions are not met, Uaccess LLC reserves the right to either refuse the return or to charge a restocking fee for not less than 15%.

Warranties

Most items sold by us are covered by a manufacturer's one-year parts / labor warranty from the purchase date.

Technical Assistance Hotline: 972-820-6450

As part of our continuing commitment to all our customers, Uaccess LLC 's sales and technical support associates can guide you in determining what products best solve your situations. With their combined experience, we're confident that our support staff have the background and talent to help you narrow your choices to the precise items that best suit your particular requirement.

WARRANTY DOES NOT INCLUDE TRAVEL CHARGES, OR ANY OTHER COSTS INCURRED FOR FIELD ACTIONS SUCH AS REPAIR, REMOVAL, INSTALLATION, SERVICING, DIAGNOSING OR HANDLING OF EITHER DEFECTIVE PARTS OR REPLACEMENT PARTS. THE MANUFACTURER'S WARRANTY APPLIES ONLY TO LOCKS RETURNED TO US FOR REPAIR.

